

**HANDBOOK FOR ANALYTICAL QUALITY CONTROL
IN WATER AND WASTEWATER LABORATORIES**

March 1979

ENVIRONMENTAL MONITORING AND SUPPORT LABORATORY
U.S. ENVIRONMENTAL PROTECTION AGENCY
OFFICE OF RESEARCH AND DEVELOPMENT
CINCINNATI, OHIO 45268

DISCLAIMER

The mention of trade names or commercial products in this handbook is for illustration purposes and does not constitute endorsement or recommendation for use by the U.S. Environmental Protection Agency.

ABSTRACT

One of the fundamental responsibilities of water and wastewater management is the establishment of continuing programs to insure the reliability and validity of analytical laboratory and field data gathered in water treatment and wastewater pollution control activities.

This handbook is addressed to laboratory directors, leaders of field investigations, and other personnel who bear responsibility for water and wastewater data. Subject matter of the handbook is concerned primarily with quality control (QC) for chemical and biological tests and measurements. Chapters are also included on QC aspects of sampling, microbiology, biology, radiochemistry, and safety as they relate to water and wastewater pollution control. Sufficient information is offered to allow the reader to inaugurate or reinforce programs of analytical QC that emphasize early recognition, prevention, and correction of factors leading to breakdowns in the validity of water and wastewater pollution control data.

ACKNOWLEDGMENTS

This handbook was prepared by the Environmental Monitoring and Support Laboratory (EMSL) of the United States Environmental Protection Agency. The contributions of the following individuals in preparing the handbook are gratefully acknowledged:

J. B. Anderson
D. G. Ballinger
E. L. Berg
R. L. Booth
R. H. Bordner
P. W. Britton
J. F. Kopp
H. L. Krieger
J. J. Lichtenberg
L. B. Lobring
J. E. Longbottom
C. I. Weber
J. A. Winter

Technical editing and preparation of the final manuscript were performed under contract to John F. Holman & Co. Inc., 1346 Connecticut Avenue, N.W., Washington, D.C. 20036.

Inquiries regarding material contained in the handbook should be made to Environmental Protection Agency, Environmental Research Center, Environmental Monitoring and Support Laboratory, Cincinnati, Ohio 45268.

TABLE OF CONTENTS

	Page	
PREFACE	iii	
ACKNOWLEDGMENTS	v	
Chapter		
1	IMPORTANCE OF QUALITY CONTROL	1-1
1.1	General	1-1
1.2	Quality Assurance Programs	1-1
1.3	Analytical Methods	1-2
1.4	Reference	1-4
2	LABORATORY SERVICES	2-1
2.1	General	2-1
2.2	Distilled Water	2-1
2.3	Compressed Air	2-5
2.4	Vacuum	2-5
2.5	Hood System	2-5
2.6	Electrical Services	2-6
2.7	References	2-6
3	INSTRUMENT SELECTION	3-1
3.1	Introduction	3-1
3.2	Analytical Balances	3-1
3.3	pH/Selective-Ion Meters	3-3
3.4	Conductivity Meters	3-6
3.5	Turbidimeters (Nephelometers)	3-7
3.6	Spectrometers	3-8
3.7	Organic Carbon Analyzers	3-13
3.8	Gas Chromatographs	3-14
3.9	References	3-14
4	GLASSWARE	4-1
4.1	General	4-1
4.2	Types of Glassware	4-2
4.3	Volumetric Analyses	4-3
4.4	Federal Specifications for Volumetric Glassware	4-4
4.5	Cleaning of Glass and Porcelain	4-5
4.6	Special Cleaning Requirements	4-6
4.7	Disposable Glassware	4-7
4.8	Specialized Glassware	4-7
4.9	Fritted Ware	4-8
4.10	References	4-9
5	REAGENTS, SOLVENTS, AND GASES	5-1
5.1	Introduction	5-1
5.2	Reagent Quality	5-1

5.3	Elimination of Determinate Errors	5-4
5.4	References	5-4
6	QUALITY CONTROL FOR ANALYTICAL PERFORMANCE	6-1
6.1	Introduction	6-1
6.2	The Industrial Approach to QC	6-1
6.3	Applying Control Charts in Environmental Laboratories	6-2
6.4	Recommended Laboratory Quality Assurance Program	6-9
6.5	Outline of a Comprehensive Quality Assurance Program	6-10
6.6	Related Topics	6-13
6.7	References	6-13
7	DATA HANDLING AND REPORTING	7-1
7.1	Introduction	7-1
7.2	The Analytical Value	7-1
7.3	Glossary of Statistical Terms	7-3
7.4	Report Forms	7-5
7.5	References	7-11
8	SPECIAL REQUIREMENTS FOR TRACE ORGANIC ANALYSIS	8-1
8.1	Introduction	8-1
8.2	Sampling and Sample Handling	8-1
8.3	Extract Handling	8-4
8.4	Supplies and Reagents	8-5
8.5	Quality Assurance	8-7
8.6	References	8-10
9	SKILLS AND TRAINING	9-1
9.1	General	9-1
9.2	Skills	9-2
9.3	Training	9-4
10	WATER AND WASTEWATER SAMPLING	10-1
10.1	Introduction	10-1
10.2	Areas of Sampling	10-2
10.3	References	10-6
11	RADIOCHEMISTRY	11-1
11.1	Introduction	11-1
11.2	Sample Collection	11-1
11.3	Laboratory Practices	11-2
11.4	Quality Control	11-4
11.5	References	11-5
12	MICROBIOLOGY	12-1
12.1	Background	12-1
12.2	Specific Needs in Microbiology	12-1
12.3	Intralaboratory Quality Control	12-2
12.4	Interlaboratory Quality Control	12-2
12.5	Development of a Formal Quality Assurance Program	12-3
12.6	Documentation of a Quality Assurance Program	12-3

	12.7 Chain-of-Custody Procedures for Microbiological Samples . .	12-3
	12.8 References	12-10
13	AQUATIC BIOLOGY	13-1
	13.1 Summary of General Guidelines	13-1
	13.2 Discussion	13-2
	13.3 Reference	13-4
14	LABORATORY SAFETY	14-1
	14.1 Law and Authority for Safety and Health	14-1
	14.2 EPA Policy on Laboratory Safety	14-5
	14.3 Laboratory Safety Practices	14-7
	14.4 Report of Unsafe or Unhealthful Condition	14-15
	14.5 References	14-15

Appendix A-Suggested Checklist for the Safety Evaluation of EPA Laboratory Areas A-1

LIST OF FIGURES

Figure No.	Page
4-1	Example of Markings on Glassware 4-5
6-1	Essentials of a Control Chart 6-2
6-2	Shewhart Control Chart for Percent Recovery Data 6-5
6-3	Procedure for Evaluating QC Data From a Monitoring Study 6-12
7-1	Example of Bench Sheet 7-8
7-2	Example of Summary Data Sheet 7-9
7-3	Example of STORET Report Form 7-10
7-4	Flow Chart of the Sequence of Events During a Controlled Series of Laboratory Measurements 7-12
12-1	Example of Chain-of-Custody Sample Tag (a) Front, (b) Back 12-5
12-2	Example of a Sample Log Sheet 12-6
12-3	Example of a Chain-of-Custody Record 12-7
14-1	Health and Safety Inspection Checklist 14-8
14-2	Report of Unhealthful or Unsafe Condition 14-16
14-3	Notice of Unhealthful or Unsafe Condition 14-17

LIST OF TABLES

Table No.	Page
2-1	Water Purity 2-1
2-2	Requirements for Reagent Water 2-2
2-3	Comparison of Distillates From Glass and Metal Stills 2-3
3-1	Performance Characteristics of Typical pH/Selective-Ion Meter 3-5
3-2	Electrical Conductivity of Potassium Chloride Reference Solutions 3-7
4-1	Tolerances for Volumetric Glassware 4-4
4-2	Fritted Ware Porosity 4-8
6-1	Analyses of Total Phosphate-Phosphorus Standards, in Milligrams Per Liter of Total PO_4 -P 6-4
6-2	Estimates of the Range ($R = A - B $) and the Industrial Statistic ($I = A - B / (A + B)$) of Three Different Parameters for Various Concentration Ranges 6-7
6-3	Shewhart Upper Control Limits UCL and Critical Range R_c Values for the Differences Between Duplicate Analyses Within Specific Con- centration Ranges for Three Parameters 6-8
6-4	Critical Range Values for Varying Concentration Levels 6-9
9-1	Skill-Time Rating of Standard Analytical Operations 9-3

10-1 Guidance for Water/Wastewater Sampling 10-2

11-1 Sample Handling, Preservation, Methodology, and Major Instrumentation
Required 11-2

Chapter 1

IMPORTANCE OF QUALITY CONTROL

1.1 General

The analytical laboratory provides qualitative and quantitative data for use in decision-making. To be valuable, the data must accurately describe the characteristics and concentrations of constituents in the samples submitted to the laboratory. In many cases, because they lead to faulty interpretations, approximate or incorrect results are worse than no result at all.

Ambient water quality standards for pH, dissolved oxygen, heavy metals, and pesticides are set to establish satisfactory conditions for drinking water, fishing, irrigation, power generation, or other water uses. The laboratory data define whether conditions are being met and whether the water can be used for its intended purposes. In wastewater analyses, the laboratory data identify the characteristics of the treatment plant influent and the final load imposed upon receiving water resources, as well as the effectiveness of steps in the treatment process. Decisions on process changes, plant modifications, or the construction of new facilities may be based upon the results of water laboratory analyses. The financial implications of such decisions suggest that extreme care be taken in analysis.

Effective research in water pollution control also depends upon a valid laboratory data base, which in turn may contribute to sound evaluations of both the progress of the research itself and the viability of available water pollution-control alternatives.

The analytical data from water and wastewater laboratories may also be used to determine the extent of compliance of a polluting industry with discharge or surface water standards. If the laboratory results indicate a violation of a standard, remedial action is required by the responsible parties. Both legal and social pressures can be brought to bear to protect the environment. The analyst should realize not only that he has considerable responsibility for providing reliable laboratory descriptions of the samples at issue, but also that his professional competence, the validity of the procedures used, and the resulting values reported may be challenged (perhaps in court). For the analyst to meet such challenges, he should support the laboratory data with an adequate documentation program that provides valid records of the control measures applied to all factors bearing on the final results of investigations.

1.2 Quality Assurance Programs

Because of the importance of laboratory analyses in determining practical courses of action that may be followed, quality assurance programs to insure the reliability of the water and wastewater data are essential. Although all analysts practice quality control (QC) in amounts depending upon their training, professional pride, and the importance of their particular projects, under actual working conditions sufficiently detailed QC may be neglected. An established, routine, quality assurance program applied to each analytical test can relieve analysts of the necessity of originating individual QC efforts.

Quality assurance programs have two primary functions in the laboratory. First, the programs should continually monitor the reliability (accuracy and precision) of the results reported; i.e., they should continually provide answers to the question “How good (accurate and precise) are the results obtained?” This function is the *determination* of quality. The second function is the *control* of quality (to meet the program requirements for reliability). As an example of the distinction between the two functions, the processing of spiked samples may be a determination of measurement quality, but the use of analytical grade reagents is a control measure.

Each analytical method has a rigid protocol. Similarly, QC associated with a test must include definite required steps for monitoring the test and insuring that its results are correct. The steps in QC vary with the type of analysis. For example, in a titration, standardization of the titrant on a frequent basis is an element of QC. In any instrumental method, calibration and checking out of instrumental response are also QC functions. All of the experimental variables that affect the final results should be considered, evaluated, and controlled.

In summary, laboratory data, in quantitative terms, e.g., in milligrams per liter, are reported by the analyst. These values are interpreted by industrial plant engineers to show compliance or noncompliance with permits for discharge, by state pollution control agencies to define the need for additional sampling and analysis to confirm violations, or by EPA to demonstrate that prescribed waste treatment was sufficient to protect the surface waters affected by the discharge.

This handbook discusses the basic factors of water and wastewater measurements that determine the value of analytical results and provides recommendations for the control of these factors to insure that analytical results are the best possible. Quality assurance programs initiated from, and based upon, these recommendations should increase confidence in the reliability of the reported analytical results.

Because ultimately a laboratory director must assume full responsibility for the reliability of the analytical results submitted, the laboratory director must also assume full responsibility in both design and implementation for the corresponding quality assurance program.

1.3 Analytical Methods

Many analytical methods for common water pollutants have been in use for many years and are used in most environmental laboratories. Examples are tests for chloride, nitrate, pH, specific conductance, and dissolved oxygen. Widespread use of an analytical method in water and wastewater testing usually indicates that the method is reliable, and therefore tends to support the validity of the reported test results. Conversely, the use of little-known analytical techniques forces the water and wastewater data user to rely on the judgment of the laboratory analyst, who must then defend his choice of analytical technique as well as his conclusions. Present Federal regulations, notably section 304(h) of Public Law 92-500 (Federal Water Pollution Control Amendments of 1977) and the Interim Drinking Water Regulations specifically require the use of EPA-approved methods of analysis.

Uniformity of methodology within a single laboratory as well as among a group of cooperating laboratories is required to remove methodology as a variable when there are many data users. Uniformity of methodology is particularly important when several

laboratories provide data to a common data bank (such as STORET*) or cooperate in joint field surveys. A lack of uniformity of methodology may raise doubts as to the validity of the reported results. If the same constituents are measured by different analytical procedures within a single laboratory, or by a different procedure in different laboratories, it may be asked which procedure is superior, why the superior method is not used throughout, and what effects the various methods and procedures have on the data values and their interpretations.

Physical and chemical measurement methods used in water or wastewater laboratories should be selected by the following criteria:

- a. The selected methods should measure desired constituents of water samples in the presence of normal interferences with sufficient precision and accuracy to meet the water data needs.
- b. The selected procedures should use equipment and skills ordinarily available in the average water pollution control laboratory or water supply laboratory.
- c. The selected methods should be sufficiently tested to have established their validity.
- d. The selected methods should be sufficiently rapid to permit repetitive routine use in the examination of large numbers of water samples.

The restriction to the use of EPA methods in all laboratories providing data to EPA permits the combination of data from different EPA programs and supports the validity of decisions made by EPA.

Regardless of which analytical methods are used in a laboratory, the methodology should be carefully documented. In some reports it is stated that a standard method from an authoritative reference (such as ref. 1) was used throughout an investigation, when close examination has indicated, however, that this was not strictly true. Standard methods may be modified or entirely replaced because of recent advances in the state of the art or personal preferences of the laboratory staff. Documentation of measurement procedures used in arriving at laboratory data should be clear, honest, and adequately referenced; and the procedures should be applied exactly as documented.

Reviewers can apply the associated precision and accuracy of each specific method when interpreting the laboratory results. If the accuracy and precision of the analytical methodology are unknown or uncertain, the data user may have to establish the reliability of the result he or she is interpreting before proceeding with the interpretation.

The necessarily strict adherence to accepted methods in water and wastewater analyses should not stifle investigations leading to improvements in analytical procedures. Even with accepted and documented procedures, occasions arise when the procedures must be modified; e.g., to eliminate unusual interferences, or to yield increased sensitivities. When

*STORET is the acronym used to identify the computer-oriented U.S. Environmental Protection Agency water quality control information system; STORET stands for STORage and RETrieval of data and information.

a modification of a procedure is necessary, it should be carefully formulated. Data should then be assembled using both the original and the modified procedures to show the superiority of the latter. Such results can be brought to the attention of the organizations responsible for standardization of procedures. To increase the benefit, the modified procedures should be written in a standard format for routine use as applicable. The standard format usually includes scope and application, principle, equipment, reagents, procedure, calculation of results, and expected precision and accuracy.

Responsibility for the results obtained from use of a nonstandard procedure (i.e., one that has not become accepted through wide use) rests with the analyst and his supervisor.

In field operations, because it may be difficult to transport samples to the laboratory, or to examine large numbers of samples (e.g., for gross characteristics), the use of rapid field methods yielding approximate answers is sometimes required. Such methods should be used only with a clear understanding that the results obtained ' are not as reliable as those obtained from standard laboratory procedures. The fact that such methods have been used should be documented, and the results should not be reported in the same context with more reliable analytical information. When only approximate values are available, perhaps obtained for screening purposes in the field only, the data user would then be so informed.

1.4 Reference

1. Standard Methods for the Examination of Water and Wastewater, 14th Edition, American Public Health Association, New York (1975).

Chapter 2

LABORATORY SERVICES

2.1 General

Quality control of water and wastewater laboratory analyses involves consideration and control of the many variables that affect the production of reliable data. The quality of the laboratory services available to the analyst must be included among these variables. An abundant supply of distilled water, free from interferences and other undesirable contaminants, is an absolute necessity. An adequate source of clean, dry, compressed air is needed. Electrical power for routine laboratory use and voltage-regulated sources for delicate electronic instrumentation must be provided. This chapter, therefore, will be devoted to describing methods of maintaining the quality of these services, as used in water and wastewater laboratory operations.

2.2 Distilled Water

Distilled or demineralized water is used in the laboratory for dilution, preparation of reagent solutions, and final rinsing of glassware. Ordinary distilled water is usually not pure. It may be contaminated by dissolved gases and by materials leached from the container in which it has been stored. Volatile organics distilled over from the feed water may be present, and nonvolatile impurities may occasionally be carried over by the steam, in the form of a spray. The concentration of these contaminants is usually quite small, and distilled water is used for many analyses without further purification. However, it is highly important that the still, storage tank, and any associated piping be carefully selected, installed, and maintained in such a way as to insure minimum contamination.

Water purity has been defined in many different ways, but one generally accepted definition states that high-purity water is water that has been distilled or deionized, or both, so that it will have a specific resistance of 500,000 Ω or greater (or a conductivity less than 2.0 $\mu\text{mho/cm}$). This definition is satisfactory as a base to work from, but for more critical requirements, the breakdown shown in table 2-1 has been suggested to express degrees of purity (1).

Table 2-1
WATER PURITY

Degree of Purity	Maximum Conductivity ($\mu\text{mho/cm}$)	Approximate Concentration of Electrolyte (mg/l)
Pure	10	2-5
Very Pure	1	0.2-0.5
Ultrapure	0.1	0.01-0.02
Theoretically Pure	0.055	0.00

The American Society for Testing and Materials (ASTM) specifies four different grades of water for use in methods of chemical analysis and physical testing. The method of preparation of the various grades of reagent water determines the limits of impurities. The various types of reagent water and ASTM requirements are listed in table 2-2.

Type I grade water is prepared by the distillation of feed water having a maximum conductivity of 20 $\mu\text{mho/cm}$ at 25°C followed by polishing with a mixed bed of ion-exchange materials and a 0.2- μm membrane filter.

Type 11 grade water is prepared by using a still designed to produce a distillate having a conductivity of less than 1.0 $\mu\text{mho/cm}$ at 25°C. This may be accomplished by double distillation or the use of a still incorporating special baffling and degassing features.

Type III grade water is prepared by distillation, ion exchange, or reverse osmosis, followed by polishing with the 0.45- μm membrane filter.

Type IV grade water is prepared by distillation, ion exchange, reverse osmosis, or electro dialysis.

Properly designed metal stills from reputable manufacturers offer convenient and reliable sources of distilled water. These stills are usually constructed of copper, brass, and bronze. All surfaces that contact the distillate should be heavily coated with pure tin to prevent metallic contamination. The metal storage tank should be of sturdy construction with a tight-fitting cover, and have a filter in the air vent to remove airborne dust, gases, and fumes.

For special purposes, an all-glass distillation unit may be preferable to the metal still. These stills are usually smaller, and of more limited capacity than the metal stills. An actual comparison in which the distillates from an all-glass still and a metal still were analyzed spectrographically for certain trace metal contaminants is given in table 2-3. It can be seen that the all-glass still produced a product that had substantially lower contamination from zinc, copper, and lead.

All stills require periodic cleaning to remove solids that have been deposited from the feed water. Hard water and high-dissolved-solids content promote scale formation in the

Table 2-2
REQUIREMENTS FOR REAGENT WATER

Grade of Water	Maximum Total Matter (mg/l)	Maximum Electrical Conductivity at 25°C ($\mu\text{mho/cm}$)	Minimum Electrical Resistivity* at 25°C ($\text{M}\Omega - \text{cm}$)	pH at 25°C	Minimum Color Retention Time of KMnO_4 (min)
Type I	0.1	0.06	16.67	–	60
Type II	0.1	1.0	1.0	–	60
Type III	1.0	1.0	1.0	6.2-7.5	10
Type IV	2.0	5.0	0.2	5.0-8.0	10

*See reference 2.

Table 2-3
COMPARISON OF DISTILLATES FROM GLASS AND
METAL STILLS

Source	Element and Concentration ($\mu\text{g/l}$)							
	Zn	B	Fe	Mn	Al	Cu	Ni	Pb
All-Glass Still	<1	12	1	<1	<5	5	<2	<2
Metal Still	9	13	2	<1	<5	11	<2	26

evaporator, and cleaning frequency will thus depend on the quality of the feed water. The boiler of an all-glass still should be drained daily and refilled with clean water. Buildup of scale is easily detected, and the boiler and condenser coils should be cleaned at frequent intervals. Metal stills usually incorporate a constant bleeder device that retards scale formation to some extent. Nevertheless, these units should be dismantled and cleaned at regular intervals. Cleaning should always be in accordance with the manufacturer's instructions.

Pretreatment of the incoming feed water will often improve still performance and raise the quality of the distillate. For example, preliminary softening of hard water removes calcium and magnesium prior to distillation. This reduces scale formation in the boiler and condenser, thereby reducing maintenance service. These softeners employ the ion-exchange principle using a sodium chloride cycle, and are relatively inexpensive to operate. A carbon filtration system, installed at the feed-water intake, will remove organic materials that might subsequently be carried over in the distillate. If trace concentrations of ions are a major concern, the distillate may be passed through a mixed-bed ion exchanger.

At least two commercially manufactured systems are available for production of high-purity water by ion exchange. The Millipore Super-Q System (Millipore Corp., Bedford, Mass.) consists essentially of disposable cartridges for prefiltration, organic absorption, deionization, and Millipore filtration. The company claims it can produce 10-M Ω water, containing no particulate matter larger than 0.45 μm in size, from tap water, at the rate of 20 gal/h. Continental Water Conditioning Corp., El Paso, Tex., advertises a system that can be tailored to the needs of the customer. Performance specifications include minimum flow rates of 45 gal/h and total dissolved solids of less than 0.1 mg/l when required.

Specific conductance is a rapid and simple measurement for determining the inorganic quality of distilled water. Stills of the types previously discussed are capable of producing a distillate with a specific conductance of less than 2.0 $\mu\text{mho/cm}$ at 25°C. This is equivalent to 0.5 to 1.0 mg/l of ionized material. Frequent checks should be made to determine that optimum performance is being maintained. A purity meter installed between the still and the storage reservoir will monitor the conductivity of the distillate, in terms of the equivalent in milligrams per liter of sodium chloride. If the reading on the meter begins to rise above the present limit of conductivity, effective action should be taken to eliminate the source of contamination. Organic quality is more difficult to monitor, but the total organic carbon determination is a simple and rapid test of organic contaminants.

A piping system for delivering distilled water to the area of use within the laboratory is a convenient feature. In this case, special care should be taken that the quality of the water is not degraded between the still and the point of use. Piping may be of tin, tin-lined brass, stainless steel, plastic, or chemically resistant glass, depending on the quality of the water desired, its intended use, and on available funds. Tin is best, but is also very expensive. As a compromise, plastic pipe or glass pipe with Teflon* O-rings at all connecting joints is satisfactory for most purposes. The glass pipe has an obvious advantage when freedom from trace amounts of organic materials is important.

When there is no piped-in supply, distilled water will probably be transported to the laboratory and stored in polyethylene or glass bottles of about 5-gal capacity. If stored in glass containers, distilled water will gradually leach the more soluble materials from the glass and cause an increase in dissolved solids. On the other hand, polyethylene bottles contain organic plasticizers, and traces of these materials may be leached from the container walls. These are of little consequence, except in some organic analyses. Rubber stoppers often used in storage containers contain leachable materials, including significant quantities of zinc. This is usually no problem, because the water is not in direct contact with the stopper. However, the analyst should be aware of the potential for contamination, especially when the supply is not replenished by frequent use.

The delivery tube may consist of a piece of glass tubing that extends almost to the bottom of the bottle, and that is bent downward above the bottle neck, with a 3- to 4-ft piece of flexible tubing attached for mobility. Vinyl tubing is preferable to latex rubber, because it is less leachable; however, a short piece of latex tubing may be required at the outlet for better control of the pinchcock. The vent tube in the stopper should be protected against the entrance of dust.

Ordinary distilled water is quite adequate for many analyses, including the determination of major cations and anions. Certain needs may require the use of double- or even triple-distilled water. Redistillation from an alkaline permanganate solution can be used to obtain a water with low organic background. When determining trace organics by solvent extraction and gas chromatography, distilled water with sufficiently low background may be extremely difficult to obtain. In this case, preextraction of the water with the solvent used in the respective analysis may be helpful in eliminating undesirable peaks in the blank. Certain analyses require special treatment or conditioning of the distilled water, and these will now be discussed.

2.2.1 Ammonia-Free Water

Removal of ammonia can be accomplished by shaking ordinary distilled water with a strong cation exchanger, or by passing distilled water through a column of such material. For limited volumes of ammonia-free water, use of the Quikpure (Box 254, Chicago, Ill.) 500-ml bottle is highly recommended. The ion-free water described in section 2.2.3 is also suitable for use in the determination of ammonia.

2.2.2 Carbon-Dioxide-Free Water

Carbon-dioxide-free water may be prepared by boiling distilled water for 15 min and cooling to room temperature. As an alternative, distilled water may be vigorously aerated with a

*Trademark of E. I. duPont de Nemours & Co.

stream of inert gas for a period sufficient to achieve saturation and CO₂ removal. Nitrogen is most frequently used. The final pH of the water should lie between 6.2 and 7.2. It is not advisable to store CO₂-free water for extended periods.

2.2.3 Ion-Free Water

A multipurpose high purity water, free from trace amounts of the common ions, may be conveniently prepared by slowly passing distilled water through an ion-exchange column containing one part of a strongly acidic cation-exchange resin in the hydroxyl form. Resins of a quality suitable for analytical work must be used. Ion-exchange cartridges of the research grade, available from scientific supply houses, have been found satisfactory. By using a fresh column and high-quality distilled water, a water corresponding to the ASTM designation for type I reagent water (2) (maximum 0.1 mg/l of total matter and maximum conductivity of 0.06 mho/cm) can be obtained. This water is suitable for use in the determination of ammonia, trace metals, and low concentrations of most cations and anions. It is not suited to some organic analyses, however, because this treatment adds organic contaminants to the water by contact with the ion-exchange materials.

2.3 Compressed Air

The quality of compressed air required in the laboratory is usually very high, and special attention should be given to producing and maintaining clean air until it reaches the outlet. Oil, water, and dirt are undesirable contaminants in compressed air, and it is important to install equipment that generates dry, oil-free air. When pressures of less than 50 psi are required, a rotary-type compressor, using a water seal and no oil, eliminates any addition of oil that would subsequently have to be removed from the system. Large, horizontal, water-cooled compressors will usually be used when higher pressures are required.

Compression heats air, thus increasing its tendency to retain moisture. An aftercooler is therefore necessary to remove water. Absorption filters should be used at the compressor to prevent moisture from entering the piping system. Galvanized steel pipe with threaded, malleable-iron fittings, or solder-joint copper tubing should be used for piping the air to the laboratory.

When the compressed air entering the laboratory is of low quality, an efficient filter should be installed between the outlet and the point of use to trap oil, moisture, and other contaminants. As an alternative, high-quality compressed air of the dry grade is commercially available in cylinders when no other source exists.

2.4 Vacuum

A source of vacuum in the chemical laboratory, while not an absolute necessity, can be a most useful item. While used primarily as an aid in filtration, it is also sometimes used in pipetting and in speeding up the drying of pipets.

2.5 Hood System

An efficient hood system is a requirement for all laboratories. In addition to removing the various toxic and hazardous fumes that may be generated when using organic solvents, or that may be formed during an acid digestion step, a hood system may also be used to remove toxic gases that may be formed during atomic absorption analyses or other

reactions. A regular fume hood should have a face velocity of 100 ft/min (linear) with the sash fully open.

2.6 Electrical Services

An adequate electrical system is indispensable to the modern laboratory. This involves having both 115- and 230-V sources in sufficient capacity for the type of work that must be done. Requirements for satisfactory lighting, proper functioning of sensitive instruments, and operation of high-current devices must be considered. Any specialized equipment may present unusual demands on the electrical supply.

Because of the special type of work, requirements for a laboratory lighting system are quite different from those in other areas. Accurate readings of glassware graduations, balance verniers, and other measuring lines must be made. Titration endpoints, sometimes involving subtle changes in color or shading, must be observed. Levels of illumination, brightness, glare, and location of light sources should be controlled to facilitate ease in making these measurements and to provide maximum comfort for the employees.

Such instruments as spectrophotometers, flame photometers, atomic absorption equipment, emission spectrographs, and gas chromatographs have complicated electronic circuits that require relatively constant voltage to maintain stable, drift-free instrument operation. If the voltage of these circuits varies, there is a resulting change in resistance, temperature, current, efficiency, light output, and component life. These characteristics are interrelated, and one cannot be changed without affecting the others. Voltage regulation is therefore necessary to eliminate these conditions.

Many instruments have built-in voltage regulators that perform this function satisfactorily. In the absence of these, a small, portable, constant-voltage transformer should be placed in the circuit between the electrical outlet and the instrument. Such units are available from Sola Basic Industries, Elk Grove Village, Ill., and are capable of supplying a constant output of 118 V from an input that varies between 95 and 130 V. When requirements are more stringent, special transformer-regulated circuits can be used to supply constant voltage. Only the instrument receiving the regulated voltage should be operated from such a circuit at any given time. These lines are in addition to, and separate from, the ordinary circuits used for operation of equipment with less critical requirements.

Electrical heating devices provide desirable heat sources, and should offer continuously variable temperature control. Hot plates and muffle furnaces wired for 230-V current will probably give better service than those that operate on 115 V, especially if the lower voltage circuit is only marginally adequate. Water baths and laboratory ovens with maximum operating temperatures of about 200°C perform well at 115 V. Care must be taken to ground all equipment that could constitute a shock hazard. The three-pronged plugs that incorporate grounds are best for this purpose.

2.7 References

1. Applebaum, S. B., and Crits, G. J., "Producing High Purity Water," *Industrial Water Engineering* (Sept./Oct. 1964).
2. "Water," Part 31 of 1977 Book of ASTM Standards, p. 20, American Society for Testing and Materials, Philadelphia (1977).

Chapter 3

INSTRUMENT SELECTION

3.1 Introduction

The modern analytical laboratory depends very heavily upon instrumentation. This statement may be completely obvious, but it should be remembered that the exceptional emphasis on electronic equipment has really begun since the development of the transistor and the computer. To a certain extent, analytical instrumentation is always in the development stage, with manufacturers continually redesigning and upgrading their products, striving for miniaturization, better durability and sensitivity, and improved automation. For laboratory supervisors and staff members the net result is a bewildering stream of advertising brochures, announcements, and catalogs of newly available equipment. Consequently, the selection of analytical equipment is always difficult.

The instruments commonly used in water and wastewater analysis include the following:

- Analytical balance
- pH/selective-ion meter
- Conductivity meter
- Turbidimeter
- Spectrometers (visible, ultraviolet (UV), infrared (IR), and atomic absorption (AA))
- Total carbon analyzer
- Gas chromatograph (GC)
- Gas chromatograph/mass spectrometer (GC/MS)
- Temperature devices (such as ovens and water baths)
- Recorders

These devices represent basic equipment used in routine work and should be the subject of careful consideration before purchase. Further, their operation and maintenance ought to be primary considerations in sustained production of satisfactory data. Obviously, fundamental understanding of instrument design will assist the analyst in the correct use of instruments and in some cases will aid in detecting instrumental failures. Calibration of all laboratory instruments with primary standards is encouraged whenever practical. This normally involves a National Bureau of Standards standard reference material or calibration and certification procedures. Calibration checks with secondary standards, made in each laboratory or available from private sources, are encouraged on a frequent basis if not required by the analytical method each time an analysis is made.

In the pages that follow an attempt is made to discuss basic instrument design and to offer some remarks about desirable instrumental features.

3.2 Analytical Balances

The most important piece of equipment in any analytical laboratory is the analytical balance. The degree of accuracy of the balance is reflected in the accuracy of all data related to weight-prepared standards. Although the balance should therefore be the most protected and cared-for instrument in the laboratory, proper care of the balance is frequently overlooked.

There are many fine balances on the market designed to meet a variety of needs. Types of balances include top-loading, two-pan, microanalytical, electroanalytical, semianalytical, analytical, and other special-purpose instruments. Each type of balance has its own place in the scheme of laboratory operation, but analytical single-pan balances are by far the most important in the production of reliable data.

Single-pan analytical balances range in capacity from the 20-g to the popular 200-g models with sensitivities from 0.01 to 1 mg. Features of single-pan balances may include mechanical and electronic switching of weights, digital readout, automatic zeroing of the empty balance, and automatic preweighing and taring capabilities. Even with all the design improvements, however, modern analytical balances are still fragile instruments, the operation of which is subject to shock, temperature, and humidity changes, to mishandling, and to various other insults. Some of the precautions to be observed in maintaining and prolonging the dependable life of a balance are as follows:

- a. Analytical balances should be mounted on a heavy, shockproof table, preferably one with an adequately large working surface and with a suitable drawer for storage of balance accessories. The balance level should be checked frequently and adjusted when necessary.
- b. Balances should be located away from laboratory traffic and protected from sudden drafts and humidity changes.
- c. Balance temperatures should be equilibrated with room temperature; this is especially important if building heat is shut off or reduced during nonworking hours.
- d. When the balance is not in use, the beam should be raised from the knife edges, the weights returned to the beam, objects such as the weighing dish removed from the pan, and the weighing compartment closed.
- e. Special precautions should be taken to avoid spillage of corrosive chemicals on the pan or inside the balance case; the interior of the balance housing should be kept scrupulously clean.
- f. Balances should be checked and adjusted periodically by a company service man or balance consultant; if service is not available locally, the manufacturer's instructions should be followed as closely as possible. Service contracts, including an automatic preventive maintenance schedule, are encouraged.
- g. The balance should be operated at all times according to the manufacturer's instructions.

Standardized weights to be used in checking balance accuracy, traceable to the National Bureau of Standards, may be purchased from various supply houses. A complete set of directions for checking the performance of a balance is contained in part 41 of ASTM Standards (1).

Because all analytical balances of the 200-g capacity suitable for water and wastewater laboratories have about the same design specifications with reference to sensitivity, precision, convenience, and price, it is safe to assume that there is no clear preference for a certain model, and selection can be made on the basis of availability of service.

3.3 pH/Selective-Ion Meters

The concept of pH as a means of expressing the degree of *effective* acidity or alkalinity instead of *total* acidity or alkalinity was developed in 1909 by Sorenson (2). It was not until about 1940 that commercial instruments were developed for routine laboratory measurement of pH.

A basic meter consists of a voltage source, amplifier, and scale or digital readout device. Certain additional refinements produce varying performance characteristics between models. Some models incorporate expanded scales for increased readability, solid state circuitry for operating stability and extreme accuracy, and temperature and slope adjustment to correct for asymmetric potential of glass electrodes. Other features are scales that facilitate use of selective-ion electrodes, recorder output, and interfacing with complex data-handling systems.

In routine pH measurements the glass electrode is used as the indicator and the calomel electrode as the reference. Glass electrodes have a very fast response time in highly buffered solutions. However, accurate readings are obtained slowly in poorly buffered samples, and particularly so when changing from buffered to unbuffered samples. Electrodes, both glass and calomel, should be well rinsed with distilled water after each reading, and should be rinsed with, or dipped several times into, the next test sample before the final reading is taken. Weakly buffered samples should be stirred during measurement. When not in use, glass electrodes should not be allowed to become dry, but should be immersed in an appropriate solution consistent with the manufacturer's instructions. The first steps in calibrating an instrument are to immerse the glass and calomel electrodes into a buffer of known pH, set the meter to the pH of the buffer, and adjust the proper controls to bring the circuit into balance. The temperature-compensating dial should be set at the temperature of the buffer solution. For best accuracy, the instrument should be calibrated against two buffers that bracket the expected pH of the samples.

The presence of a faulty electrode is indicated by failure to obtain a reasonably correct value for the pH of the second reference buffer solution after the meter has been standardized with the first reference buffer solution. A cracked glass electrode will often yield pH readings that are essentially the same for both standards. The response of electrodes may also be impaired by failure to maintain the KCl level in the calomel electrode, by improper electrode maintenance, or by certain materials such as oily substances and precipitates that may coat the electrode surface. Faulty electrodes can often be restored to normal by an appropriate cleaning procedure. Complete and detailed cleaning methods are given in part 31 of ASTM Standards (3), and are also usually supplied by the electrode manufacturer.

Because of the asymmetric potential of the glass electrode, most pH meters are built with a slope adjustment that enables the analyst to correct for slight electrode errors observed during calibration with two different pH buffers. Exact details of slope adjustment and slope check may vary with different models of instruments. The slope adjustment must be made whenever electrodes are changed, subjected to vigorous cleaning, or refilled with fresh electrolyte. The slope adjustment feature is highly desirable and recommended for consideration when purchasing a new meter.

Most pH meters now available are built with transistorized circuits rather than vacuum tubes, which greatly reduces the warmup time and increases the stability of the meters.

Also, many instruments are designed with a switching circuit so that the entire conventional 0 to 14 scale of pH may be used to read a single pH unit with a corresponding increase in accuracy.

This expanded-scale feature is of definite value when the meter is used for potentiometric titrations and selective-ion work. It is of dubious value, however, in routine analyses, because pH readings more precise than ± 0.1 are seldom required. Primary standard buffer salts are available from the National Bureau of Standards* and should be used in situations where extreme accuracy is necessary. Preparation of reference solutions from these salts requires some special precautions and handling (3,4) such as the use of low-conductivity dilution water, drying ovens, and carbon-dioxide-free purge gas. These solutions should be replaced at least once each month.

Secondary standard buffers may be prepared from NBS salts or purchased as solutions from commercial vendors. Routine use of these commercially available solutions, which have been validated by comparison to NBS standards, is recommended.

The electrometric measurement of pH varies with temperature because of two effects. The first effect is the change in electrode output with temperature. This interference can be controlled by use of instruments having temperature compensation or by calibrating the instrument system including the electrode at the temperature of the samples. The second effect is the change of pH of the sample with temperature. This error is sample dependent and cannot be controlled; it should therefore be noted by reporting both the pH and temperature at the time of analysis.

Typical characteristics of a conventional expanded-scale meter are shown in table 3-1.

3.3.1 pH Electrodes

A wide variety of special- and general-purpose pH electrodes are now available to meet all applications in the general analytical laboratory. A survey through any laboratory supply catalog may confuse more than clarify the selection process. A rugged, full-range, glass- or plastic-bodied combination electrode is a good choice for routine use. An added convenience is an electrode that contains solid geltype filling materials not requiring the normal maintenance of an electrode containing liquid filling solutions.

3.3.2 Selective-Ion Electrodes

Electrodes have been developed to measure almost every common inorganic ion normally measured in the water and wastewater laboratory. Application of these electrodes has progressed at a much slower pace and currently only three are approved for EPA monitoring applications.

Reference 5 includes methods for use of fluoride, ammonia, and dissolved oxygen electrodes. Various techniques for use of these and other electrodes are reviewed in references 6 through 9. A major problem in measuring the total parameter with electrodes is that of relating the ion activity to ion concentration. Because the electrodes only measure

*NBS, Office of Standard Reference Materials, Institute for Materials Research, Washington, D.C. 20234.

Table 3-1
PERFORMANCE CHARACTERISTICS OF TYPICAL pH/SELECTIVE-ION METERS

Scale	Range		Smallest Scale Division		Accuracy		Reproducibility		Temperature Compensation ¹ (°C)	Input Impedance (Ω)	Power Requirements	
	(pH)	(mV)	(pH)	(MV)	(pH)	(mV)	(pH)	(mV)			(V)	(Hz)
Normal	0-14	±1,400	0.1	10	±0.05	±5	±0.02	±2	0-100	>10	² 115/220	50/60
Expanded	0-1	±100	.005	.5	±0.002	(³)	±0.002	±0.2	0-100	>10	² 115/220	50/60

¹ Manual or automatic.

² May also be powered by self-contained batteries.

³ ±2 percent of reading.

activity, the challenge is to put all of the parameters of interest into the same measurable ionic form and then to modify the activity to be proportional to the concentration. The technique of known addition (spiking of samples) is recommended when unproven electrode methods are being used or when sample matrix problems are suspected or not controlled by prior distillation or separation techniques.

3.4 Conductivity Meters

Solutions of electrolytes conduct an electric current by the migration of ions under the influence of an electric field. For a constant applied EMF, the current flowing between opposing electrodes immersed in the electrolyte will vary inversely with the resistance of the solution. The reciprocal of the resistance is called conductance and is expressed in reciprocal ohms (mhos). For natural water samples where the resistance is high, the usual reporting unit is micromhos.

Most conductivity meters on the market today use a cathode-ray tube, commonly known as the "magic eye," for indicating solution conductivity. A stepping switch for varying resistances in steps of $10\times$ facilitates reading conductivities from about 0.1 to about 250,000 μmho . The sensing element for a conductivity measurement is the conductivity cell, which normally consists of two thin plates of platinized metal, rigidly supported with a very precise parallel spacing. For protection, the plates are mounted inside a glass tube with openings in the side walls and submersible end for access of sample. Variations in designs have included use of hard rubber and plastics for protection of the cell plates. Glass may be preferable, in that the plates may be visually observed for cleanliness and possible damage, but the more durable encasements have the advantage of greater protection and reduced cell breakage. Selection of various cell designs is normally based on personal preference with consideration of sample type and durability requirements.

In routine use, cells should be frequently examined to insure that (a) the platinized coating of plates is intact; (b) plates are not coated with suspended matter; (c) plates are not bent, distorted, or misaligned; and (d) lead wires are properly spaced.

Temperature has a pronounced effect on the conductance of solutions, and must be corrected for when results are reported. The specified temperature for reporting data used by most analytical groups (and all EPA laboratories) is 25°C . Data correction may be accomplished by adjusting sample temperatures to 25°C , or by use of mathematical or electronic adjustment.

Instrumental troubles are seldom encountered with conductivity meters because of the design simplicity. When troubles occur, they are usually in the cell, and for most accurate work the following procedures should be used:

- a. Standardize the cell and establish a cell factor by measuring the conductivity of a standard potassium chloride solution (standard conductivity tables may be found in various handbooks).
- b. Rinse the cell by repeated immersion in distilled water.
- c. Again, immerse the cell in the sample several times before obtaining a reading.

- d. If the meter is equipped with a magic eye, determine the maximum width of the shadow at least twice, once by approaching the endpoint from a low reading upward, and once from a high reading downward.

Because the cell constants are subject to slow change even under ideal conditions, and sometimes to more rapid change under adverse conditions, it is recommended that the cell constant be periodically established. Table 3-2 can be used for this operation.

For instruments reading in mhos, the cell constant is calculated as follows:

$$L = \frac{K_1 + K_2}{10^6 K_x}$$

where

L = cell constant

K₁ = conductivity, in micromhos per centimeter, of the KCl solution at the temperature of measurement

K₂ = conductivity, in micromhos per centimeter, of the KCl solution at the same temperature as the distilled water used to prepare the reference solution

K_x = measured conductance, in mhos

Many different manufacturers produce conductivity meters that perform well on water and wastewater samples. Selection should be made consistent with sampling requirements, availability of service and sales, and individual personal preference.

3.5 Turbidimeters (Nephelometers)

Many different instrument designs have been used for the optical measurement of turbidity by measurement of either transmission or reflection of light. An equal or even greater

Table 3-2
ELECTRICAL CONDUCTIVITY OF POTASSIUM CHLORIDE REFERENCE SOLUTIONS

Solution	Normality	Method of Preparation	Temperature (°C)	Conductivity (μmho/cm)
A	0.1	7.4365 g/l KCl at 20°C	0	7,138
			18	11,167
			25	12,856
B	0.01	0.7440 g/l KCl at 20°C	0	773
			18	1,220
			25	1,408
C	0.001	Dilute 100 ml of B to 1.0 l at 20°C	25	147

number of materials have been used or proposed as calibration standards. As described in reference 10, EPA has standardized on the instrument design and the standard turbidity suspension of Formazin for instrument calibration.

Both the analyst and the user of turbidity data should keep in mind that a turbidity measurement is not a substitute for particle weight or residue analysis. Turbidity instruments can be calibrated to give gravimetric data on specific sample types, but the influence of particle geometry, specific gravity, refractive index, and color make estimates of total weight impractical on a variety of sample types.

For production of data with maximum accuracy and precision, the following precautions should be observed:

- a. Protect the sample cuvette from scratches and fingerprints.
- b. Use a constant orientation of the sample cuvette while calibrating the instrument and analyzing samples.
- c. Use a well-mixed sample in the sample cuvette; do not take readings until finely dispersed bubbles have disappeared.
- d. Dilute samples containing excess turbidity to some value below 40 nephelometric turbidity units (NTU); take reading; and multiply results by correct dilution factor.

3.6 Spectrometers

Because a large portion of routine quantitative measurements are performed colorimetrically, the spectrometer or filter photometer is usually the workhorse of any analytical laboratory. Indeed, the versatility of such instruments and the number of demands imposed upon them have resulted in a variety of designs and price ranges. Systematic listing and detailed discussion of all instrumental types are beyond the scope of this chapter; however, ultraviolet, visible, infrared, and atomic absorption instruments will be discussed.

A spectrometer is an instrument for measuring the amount of light or radiant energy transmitted through a solution or solid material as a function of wavelength. A spectrometer differs from a filter photometer in that it uses continuously variable, and more nearly monochromatic, bands of light. Because filter photometers lack the versatility of spectrometers, they are used most profitably where standard methodologies are used for routine analysis.

The essential parts of a spectrometer include the following:

- a. A source of radiant energy
- b. Monochromator or other device for isolating narrow spectral bands of light
- c. Cells (cuvettes) or sample holders for containing samples under investigation
- d. A photodetector (a device to detect and measure the radiant energy passing through the sample)

Each of the essential features listed, especially the monochromator and the photodetector system, varies in design principles from one instrument to another. Some of the characteristics of the commonly used Perkin-Elmer model 124 double-beam grating spectrometer are the following:

Light source	
Visible region	Tungsten
Lamp UV region	Deuterium lamp
Wavelength accuracy	±0.5 nm
Spectral bandwidth	0.5, 1.0, and 2.0 nm
Photometric presentation	
Linear transmittance	0 to 100 percent
Linear absorbance	0 to 1A or 0 to 2A
Photodetector R- 136	190 to 800 nm
Sample cells	1.0 to 10 cm

3.6.1 Visible Range

Desirable features on a visible-range spectrometer are determined by the anticipated use of the instrument. Simple, limited programs requiring use of only a few parameters can probably be supported by inexpensive but reliable filter photometers. On the other hand, if the laboratory programs require a wide variety of measurements on diverse samples at low concentrations, more versatile instruments may be needed. One of the prime considerations is adaptability to various sample cell sizes from 1.0 to 10.0 cm.

3.6.2 Ultraviolet Range

A UV spectrometer is similar in design to a visible-range instrument except for differences in the light source and in the optics. The UV light source is a hydrogen- or deuterium-discharge lamp, which emits radiation in the UV portion of the spectrum, generally from about 200 nm to the low-visible-wavelength region. The optical system and sample cells must be constructed of UV-transparent material, which is usually quartz. A grating used in a UV system may be specially cut (blazed) in the UV region for greater sensitivity.

3.6.3 Infrared Range

A number of instrumental modifications are required in the construction of spectrometers for measurements in the IR region because materials such as glass and quartz absorb IR radiant energy, and ordinary photocells do not respond to it. Most IR spectrometers use front-surfaced mirrors to eliminate the necessity for the transmission of radiant energy through quartz, glass, or other lens materials. These mirrors are usually parabolic to focus the diffuse IR energy. Such instruments must be protected from high humidities and water vapor to avoid deterioration of the optical system and the presence of extraneous absorption bands in the IR.

The energy or light source for an IR instrument may be a Nernst glower or a Globar. Each of these sources has certain characteristics that recommend it for use, but the more rugged Globar is more commonly used because it also has a more stable emission. The receiving or detection unit may be a thermocouple, bolometer, thermistor, or photoconductor cell. The type of analysis being performed dictates the degree of sophistication required in the IR instrumentation selected to acquire usable data.

3.6.4 Proper Use of Spectrometers

The spectrometer manufacturer's instructions for proper use should be followed in all cases. Several safeguards against misuse of the instruments, however, are mandatory.

Instruments should be checked for wavelength alignment. If a particular colored solution is to be used at a closely specified wavelength, considerable loss of sensitivity can be encountered if the wavelength control is misaligned. In visible-range instruments, an excellent reference point is the maximum absorption for a diluted solution of potassium permanganate, which has dual peaks at 526 and 546 nm. On inexpensive instruments with less resolution the permanganate peak appears at 525 to 550 nm as a single, flat-topped peak.

For both UV and IR instruments, standard absorption curves for many organic materials have been published so that reference material for standard peaks is easily available. Standard films of styrene and other transparent plastics are available for IR wavelength checks. A very good discussion of factors that affect the proper performance of spectrometers and standard reference materials available to calibrate them can be found in publications of the National Bureau of Standards.* Use of certified standards is encouraged whenever practical.

Too much emphasis cannot be placed on care of absorption cells. All absorption cells should be kept scrupulously clean, free of scratches, fingerprints, smudges, and evaporated film residues. Matched cells should be checked to see that they are equivalent, and any differences should be accounted for during use or in the final data. Directions for cleaning cells are given in chapter 4.

Generally speaking, trained technicians may operate any of the spectrometers successfully; however, because interpretation of data from both the UV and IR instruments is becoming increasingly complex, mere compliance with the operations manual may not be sufficient for completely accomplishing the special techniques of sample preparation, instrument operation, and interpretation of absorption curves.

3.6.5 Atomic Absorption

There are a number of differences in the basic design and accessories for atomic absorption (AA) equipment that require consideration before purchase and during subsequent use. These choices concern the light sources, nebulizer burners, optical systems, readout devices, and mode conversions. Because some of these choices are not readily obvious, the purchaser or user must be familiar with the types and numbers of samples to be analyzed and

*NBS, Office of Standard Reference Materials, Institute for Materials Research, Washington, D.C. 20234.

the specific elements to be measured before making the choice. For a program analyzing a wide variety of samples for a number of elements at varying concentrations, an instrument of maximum versatility would be best. Most of the discussion that follows applies to use of instrumentation in absorption, emission, or fluorescence modes.

3.6.5.1 Lamps

Hollow-cathode (HC) lamps or electrodeless-discharge lamps (EDL) are available for over 70 elements with single-element or multielement capability. Multielement lamps are considerably cheaper per element than single-element lamps, but the savings may not be realized if the lamps are not used strategically, because all the elements in the cathode deteriorate when the lamp is used, regardless of which element is measured. The deterioration phenomena result from the different volatilities of metals used in the cathode. One metal volatilizes (sputters) more rapidly than the others and redeposits upon an area of the other cathode metals. Thus, with continual use, a drift in signal will be noted with at least one metal increasing and the other (or others) decreasing. If one can ignore the dubious cost savings of multielement lamps, use of single-element lamps could result in more precise and accurate data.

The line intensities of one element in a multielement HC lamp will usually be less than those of a lamp containing a pure cathode of the same element because this element must share the discharge energy with the other elements present. However, this reduction should not affect the output by a factor of more than one-sixth to one-half, depending on the particular combination and the number of elements combined. The output can be even greater in some multielement lamps because alloying may permit a higher operating current than for the case of the pure cathode. All HC lamps have life expectancies that are related to the volatility of the cathode metal, and for this reason the manufacturer's recommendations for operating should be closely followed.

Recent improvements in design and manufacture of HC lamps and EDLs have resulted in lamps with more constant output and longer life. Under normal conditions an HC lamp may be expected to operate satisfactorily for several years. HC lamps used to be guaranteed for a certain minimum ampere-hour period, but this has been changed to a 90-day warranty. It is good practice to date newly purchased lamps and to inspect them immediately upon receipt. The operating current and voltage indicated on the lamp should not be exceeded during use. An increase in background noise or a loss of sensitivity are signs of lamp deterioration.

A basic design feature of AA spectrometers is the convenience of the HC lamp changeover system. Some instruments provide for as many as six lamps in a rotating turret, all electronically stabilized and ready for use by simply rotating the lamp turret. Other instruments provide for use of only one lamp at a time in the lamp housing, and require manual removal and replacement whenever more than one element is to be measured. A quick-changeover system enables frequent lamp changes during the period of operation. If necessary lamp changes are infrequent, however, multilamp mounts do not represent a great convenience.

After the proper lamp has been selected, the HC current should be adjusted according to the manufacturer's recommendations and allowed to electronically stabilize (warm up) before use. During this 15-min period, the monochromator may be positioned at the correct wavelength, and the proper slit width may be selected. For those instruments employing a multilamp turret, a warmup current is provided to those lamps not in use, thereby

minimizing the warmup period after the turret is rotated. In a single-lamp instrument, the instability exhibited during warmup is minimized by the use of a double-beam optical system.

3.6.5.2 Burner Types

The most difficult and inefficient step in the AA process is converting the metal in the sample from an ion or a molecule to the neutral atomic state. It is the function of the atomizer/burner to produce the desired neutral atomic condition of the elements. With minor modifications burners are the same as those used for flame photometry.

Basically there are two different types of burners. They are the total-consumption, or surface-mix burner, and the laminar-flow or premix burner. There are many variations of these two basic types, such as the Boling, the high-solids, the turbulent-flow, the triflame, the nitrous oxide burners, and many others. As one might expect, there are many similarities among the various burners, the different names resulting from the different manufacturers. The element being determined and the type of sample solution dictate the type of burner to be used. Generally, all types and makes of burner can be adjusted laterally, rotationally, and vertically for selection of the most sensitive area of the flame for the specific element sought.

Nonflame techniques have gained wide acceptance in AA analysis because of the extreme sensitivity and the capability to directly introduce very diverse sample matrices. These systems, which replace the conventional flame burner, come in various designs using electrical resistance to produce temperatures as high as 3,500°C.

3.6.5.3 Single- and Double- (Split-) Beam Instruments

There is a great deal of existing uncertainty among instrument users about the relative merits of single- and double-beam instruments. Neither system is appropriate for all cases.

With a single-beam instrument the light beam from the source passes directly through the flame to the detector. In a double-beam system the light from the source is divided by a beam splitter into two paths. One path, the reference beam, goes directly to the detector. The second path, the sample beam, goes through the flame to the detector. The chopper alternately reflects and passes each beam, creating two equal beams falling alternately upon the detector. If the beams are equal, they cancel the alternate impulses reaching the detector, and no signal is generated. If the beams are different, the resulting imbalance causes the detector to generate a signal that is amplified and measured. The difference between the reference and sample beams is then determined as a direct function of absorbed light. The advantages of the double-beam design are that any variations in the source are of reduced importance, and smaller dependence is placed upon the stability of the power supply. Conversely, stabilization of the power supply can eliminate the apparent need for the split-beam system. Furthermore, the beam splitter requires additional mirrors or optical accessories that cause some loss of radiant energy.

A single-beam system does not monitor source variations, but offers certain other advantages. It allows use of low-intensity lamps, smaller slit settings, and smaller gain. As a consequence, the single-beam instrument, properly designed, is capable of operating with lower noise and better signal-to-noise ratio, and therefore with better precision and improved sensitivity. Because the simplified optical system conserves radiant energy,

especially in the shorter wavelengths, it facilitates operation in the low-wavelength range. With this advantage, it should be possible to obtain better sensitivity for those elements with a strong resonance line below 350 nm and particularly those below 300 nm. Background correction techniques are also available in single-beam systems.

Double-beam instruments, however, offer the opportunity to perform more sophisticated techniques like background correction, two-channel multielement analysis, use of internal standards, and element rationing. If one of these techniques is necessary, a double-beam instrument must be considered.

3.6.5.4 Readout Devices

Readout devices in even the lower cost AA instruments include digital concentration display. Using high-speed digital electronics, data-handling techniques encompass multiple calibration standards, regression analysis to characterize the calibration curves, mean variance and standard deviation statistical programs for sample calculations, and various forms of printout reports in addition to recorder output. Choice of a readout system is predicated largely upon laboratory needs and availability of budget. In general, any step toward automation is desirable, but the degree of automation should be compatible with the laboratory program.

3.6.5.5 Miscellaneous Accessories

A number of instruments contain a mode selector, making an instrument usable for either absorption or emission. The conversion to emission may be a desirable feature because certain elements are more amenable to analysis by this method. Some models offer an option of atomic fluorescence and can also be used as a UV/visible spectrometer.

Automatic sample changers are offered for almost all instruments on the market, and as has been previously stated, any automation feature is desirable. However, unless a laboratory program performs a large number of repetitious measurements daily, an automatic sample changer is not required. As a practical measure, other commonly used sample-changing devices, although not expressly designed for AA use, can be interfaced with most AA instruments.

3.7 Organic Carbon Analyzers

A number of instruments designed to measure total organic carbon (TOC) in waters and wastes have appeared on the market in the past several years. The first of these units involved pyrolysis followed by IR measurement of the carbon dioxide formed. Sample injection of 20 to 200 μl in a carrier gas of air or oxygen was performed with a syringe. Combustion at 800°C to 900°C followed by IR analysis was performed automatically with final output on an analog recorder. Systems using these principles are still produced and represent a large part of the TOC market.

Other techniques of TOC analysis that modify every phase of the original TOC instruments have been introduced. Sample presentation in small metallic boats and purging of CO_2 from solution are two new techniques. Wet chemical oxidation, either external to the instrument or within the instrument, using various oxidants including ultraviolet irradiation is now in wide use. Measurement of the CO_2 by reduction to methane (CH_4) and quantitation with a flame ionization detector are also available. Various methods of data handling are now used,

ranging from recorder output to direct readings and printouts of concentration. Techniques are also available for measuring materials like soil and sludges, and also the volatile component of the TOC. Sensitivity on some systems has been extended down to the microgram per liter level. The major problems associated with TOC measurements are interference from forms of inorganic carbon and the difficulty of obtaining a representative sample in the presence of particulate matter. Each system has its own procedure for sample pretreatment or for accounting for these problems. When choosing a TOC instrument, consideration should be given to the types of samples to be analyzed, the expected concentration range, and the forms of carbon to be measured.

3.8 Gas Chromatographs

Because GC's are available from a large number of manufacturers, selection of a particular manufacturer may be based on convenience. No single multipurpose GC instrument permits analysis of a wide range of compounds. In this case, a GC/MS could be considered (11). If, however, relatively few types of environmentally significant compounds are being surveyed, an inexpensive system equipped with a glass-lined injection port, electrolytic conductivity detector, and analog recorder is a good choice. A review of the organic methods (12) to be used will give the analyst all the necessary information on the specific instrument, apparatus, and materials necessary for each type or class of compounds. A discussion of various quality control considerations in GC analysis is given in chapter 8 of this manual.

Data handling requirements vary widely, and the need to automate GC data collection is determined by the extent of the sample load. In a routine monitoring laboratory, GC systems incorporating their own microprocessors and report generating capabilities would be useful in solving this problem. Because such systems greatly increase the cost, the overall economy of this choice must be considered.

3.9 References

1. "Single Arm Balances Testing," Part 41 of 1976 Book of ASTM Standards, American Society for Testing and Materials, Philadelphia (1976).
2. Sorenson, S. P. L., *Biochem. Z.*, *21*, 201 (1909).
3. "pH of Water and Wastewater," from Part 31 of 1976 Book of ASTM Standards, American Society for Testing and Materials, Philadelphia (1976).
4. Catalog of NBS Standard Reference Materials, NBS Special Publication 260, National Bureau of Standards (1975-76).
5. Methods for Chemical Analysis of Water and Wastes, U.S. EPA, Office of Research and Development, EMSL, Cincinnati (1978).
6. Rechnitz, G. A., "Ion-Selective Electrodes," *Chem. Eng. News* (June 12, 1967), p. 146.
7. Riseman, Jean M., "Measurement of Inorganic Water Pollutants by Specific Ion Electrode," *American Laboratory* (July 1969), p. 32.
8. Koryta, Jiri, "Theory and Application of Ion-Selective Electrodes," *Anal. Chim. Acta*, *61*, 329-411 (1972).
9. Covington, A. L., "Ion-Selective Electrodes," *CRC Critical Review in Anal. Chem.* (Jan. 1974), pp. 355-406.
10. Black, A. P., and Hannah, S. A., "Measurement of Low Turbidities," *J. Am. Water Works Assoc.*, *57*, 901 (1965).
11. EPA GC/MS Procedural Manual, Budde, W. L., and Eichelberger, J. W., Editors, 1st Edition, Vol. 1, U.S. EPA, Office of Research and Development, EMSL, Cincinnati (in press).

12. Methods for Organic Analysis of Water and Wastes, U.S. EPA, EMSL, Environmental Research Center, Cincinnati (in preparation).

Chapter 4

GLASSWARE

4.1 General

The measurement of trace constituents in water demands methods capable of maximum sensitivity. This is especially true for metals and trace organics such as pesticides, as well as for the determination of ammonia and phosphorus. In addition to sensitive methods, however, there are other areas that require special consideration. One such area is that of the cleanliness of laboratory glassware. Obviously, the very sensitive analytical systems are more sensitive to errors resulting from the improper use or choice of apparatus, as well as to contamination effects due to an improper method of cleaning the apparatus. The purpose of this chapter is to discuss the kinds of glassware available, the use of volumetric ware, and various cleaning requirements.

4.2 Types of Glassware

Laboratory vessels serve three functions: storage of reagents, measurement of solution volumes, and confinement of reactions. For special purposes, vessels made from materials such as porcelain, nickel, iron, aluminum, platinum, stainless steel, and plastic may be employed to advantage. Glass, however, is the most widely used material of construction. There are many grades and types of glassware from which to choose, ranging from student grade to others possessing specific properties such as super strength, low boron content, and resistance to thermal shock or alkali. Soft glass containers are not recommended for general use, especially for storage of reagents because of the possibility of dissolving of the glass (or of some of the constituents of the glass). The mainstay of the modern analytical laboratory is a highly resistant borosilicate glass, such as that manufactured by Corning Glass Works under the name "Pyrex" or by Kimble Glass Co. as "Kimax." This glassware is satisfactory for all analyses included in reference 1.

Depending on the particular manufacturer, various trade names are used for specific brands possessing special properties such as resistance to heat, shock, and alkalis. Examples of some of these special brands follow:

- a. Kimax- or Pyrex-brand glass is a relatively inert all-purpose borosilicate glass.
- b. Vycor-brand glass is a silica glass (96 percent) made to withstand continuous temperatures up to 900°C and can be down-shocked in ice water without breakage.
- c. Corning-brand glass is claimed to be 50 times more resistant to alkalis than conventional ware and practically boron-free (maximum 0.2 percent).
- d. Ray-Sorb- or Low-Actinic-brand glass is used when the reagents or materials are light sensitive.
- e. Corex-brand labware is harder than conventional borosilicates and therefore better able to resist clouding and scratching.

The use of plastic vessels, containers, and other apparatus made of Teflon, polyethylene, polystyrene, and polypropylene has increased markedly over recent years. Some of these

materials, such as Teflon, are quite expensive; however, Teflon stopcock plugs have practically replaced glass plugs in burets, separatory funnels, etc., because lubrication to avoid sticking or “freezing” is not required. Polypropylene, a methylpentene polymer, is available as laboratory bottles, graduates, beakers, and even volumetric flasks. It is crystal clear, shatterproof, autoclavable, and chemically resistant.

The following are some points to consider in choosing glassware or plasticware:

- a. The special types of glass listed above, other than Pyrex or Kimax, generally are not required to perform the analyses given in “Methods for Chemical Analysis of Water and Wastes” (1).
- b. Unless instructed otherwise, borosilicate or polyethylene bottles may be used for the storage of reagents and standard solutions.
- c. Dilute metal solutions are prone to plate out on container walls over long periods of storage. Thus, dilute metal standard solutions must be prepared fresh at the time of analysis.
- d. For some operations, disposable glassware is entirely satisfactory. One example is the use of disposable test tubes as sample containers for use with the Technicon automatic sampler.
- e. Plastic bottles of polyethylene and Teflon have been found satisfactory for the shipment of water samples. Strong mineral acids (such as sulfuric acid) and organic solvents will readily attack polyethylene and are to be avoided.
- f. Borosilicate glassware is not completely inert, particularly to alkalies; therefore, standard solutions of silica, boron, and the alkali metals are usually stored in polyethylene bottles.

For additional information the reader is referred to the catalogs of the various glass and plastic manufacturers. These catalogs contain a wealth of information such as specific properties, uses, and sizes.

4.3 Volumetric Analyses

By common usage, accurately calibrated glassware for precise measurements of volume has become known as volumetric glassware. This group includes volumetric flasks, volumetric pipets, and accurately calibrated burets. Less accurate types of glassware including graduated cylinders and serological and measuring pipets also have specific uses in the analytical laboratory when exact volumes are unnecessary.

The precision of volumetric work depends in part upon the accuracy with which volumes of solutions can be measured. There are certain sources of error that must be carefully considered. The volumetric apparatus must be read correctly; that is, the bottom of the meniscus should be tangent to the calibration mark. There are other sources of error, however, such as changes in temperature, which result in changes in the actual capacity of glass apparatus and in the volume of the solutions. The capacity of an ordinary glass flask of 1000-ml volume increases 0.025 ml/deg with rise in temperature, but if the flask is made of borosilicate glass, the increase is much less. One thousand milliliters of water or of most 0.1N solutions increases in volume by approximately 0.20 ml/deg increase at room

temperature. Thus solutions must be measured at the temperature at which the apparatus was calibrated. This temperature (usually 20°C) will be indicated on all volumetric ware. There may also be errors of calibration of the apparatus; that is, the volume marked on the apparatus may not be the true volume. Such errors can be eliminated only by recalibrating the apparatus or by replacing it.

Volumetric apparatus is calibrated to contain or to deliver a definite volume of liquid. This will be indicated on the apparatus with the letters "TC" (to contain) or "TD" (to deliver). Volumetric flasks are calibrated to contain a given volume and are available in various shapes and sizes.

Volumetric pipets are calibrated to deliver a fixed volume. The usual capacities are 1 through 100 ml although micropipets are also available. Micropipets are most useful in furnace work and are available in sizes ranging from 1 to 100 μ l.

In emptying volumetric pipets, they should be held in a vertical position and the outflow should be unrestricted. The tip of the pipet is kept in contact with the wall of the receiving vessel for a second or two after the free flow has stopped. *The liquid remaining in the tip is not removed*; this is most important.

Measuring and serological pipets should also be held in a vertical position for dispensing liquids; however, the tip of the pipet is only touched to the wet surface of the receiving vessel after the outflow has ceased. For those pipets where the small amount of liquid remaining in the tip is to be blown out and added, indication is made by a frosted band near the top.

Burets are used to deliver definite volumes. The more common types are usually of 25- or 50-ml capacity, graduated to tenths of a milliliter, and are provided with stopcocks. For precise analytical methods in microchemistry, microburets are also used. Microburets generally are of 5- or 10-ml capacity, graduated in divisions of hundredths of a milliliter. Automatic burets with reservoirs are also available ranging in capacity from 10 to 100 ml. Reservoir capacity ranges from 100 to 4,000 ml.

General rules in regard to the manipulation of a buret are as follows: Do not attempt to dry a buret that has been cleaned for use, but rinse it two or three times with a small volume of the solution with which it is to be filled. Do not allow alkaline solutions to stand in a buret because the glass will be attacked, and the stopcock, unless made of Teflon, will tend to freeze. A 50-ml buret should not be emptied faster than 0.7 ml/s, otherwise too much liquid will adhere to the walls and as the solution drains down, the meniscus will gradually rise, giving a high false reading. It should be emphasized that improper use or reading of burets can result in serious calculation errors.

In the case of all apparatus for delivering liquids, the glass must be absolutely clean so that the film of liquid never breaks at any point. Careful attention must be paid to this fact or the required amount of solution will not be delivered. The various cleaning agents and their use are described later.

4.4 Federal Specifications for Volumetric Glassware

Reference 2 contains a description of Federal specifications for volumetric glassware. The National Bureau of Standards no longer accepts stock quantities of volumetric apparatus

from manufacturers or dealers for certification and return for future sale to consumers. This certification service is still available, but apparatus will be tested only when submitted by the ultimate user, and then only after an agreement has been reached with the Bureau concerning the work to be done.

Consequently, the various glass manufacturers have discontinued the listing of NBS-certified ware. In its place catalog listings of volumetric glass apparatus that meet the Federal specifications are designated as class A and all such glassware is permanently marked with a large "A." These NBS specifications are listed in table 4-1. The glassware in question includes the usual burets, volumetric flasks, and volumetric pipets.

In addition to the "A" marking found on calibrated glassware and the temperature at which the calibration was made, other markings also appear. These include the type of glass, such

Table 4-1
TOLERANCES FOR VOLUMETRIC
GLASSWARE¹

Type of Glassware	Capacity ² (ml)	Limit of Error (ml)
Graduated flask	25	0.03
	50	0.05
	100	0.08
	200	0.10
	250	0.11
	300	0.12
	500	0.15
	1,000 2,000	0.30 0.50
Transfer pipet	2	0.006
	5	0.01
	10	0.02
	25	0.025
	30	0.03
	50	0.05
	100	0.08
	200	0.10
Buret ³	5	0.01
	10	0.02
	30	0.03
	50	0.05
	100	0.01

¹ Abridged from reference 3.

² Less than and including.

³ Limits of error are of total or partial capacity. Customary practice is to test the capacity at five intervals.

as Pyrex, Corex, or Kimax; the stock number of the particular item; and the capacity of the vessel. If the vessel contains a ground-glass connection, this will also be included along with the TD or TC symbol. An example of the markings usually found on volumetric ware is shown in figure 4-1. Class A glassware need not be recalibrated before use. However, if it should become necessary to calibrate a particular piece of glassware, directions may be found in texts (4) on quantitative analysis.

4.5 Cleaning of Glass and Porcelain

The method of cleaning should be adapted to both the substances that are to be removed, and the determination to be performed. Water-soluble substances are simply washed out with hot or cold water, and the vessel is finally rinsed with successive small amounts of distilled water. Other substances more difficult to remove may require the use of a detergent, organic solvent, dichromate cleaning solution, nitric acid, or aqua regia (25 percent by volume concentrated HNO_3 in concentrated HCl). In all cases it is good practice to rinse a vessel with tap water as soon as possible after use. Material allowed to dry on glassware is much more difficult to remove.

Volumetric glassware, especially burets, may be thoroughly cleaned by a mixture containing the following: 30 g of sodium hydroxide, 4 g of sodium hexametaphosphate (trade name, Calgon), 8 g of trisodium phosphate, and 1 l of water. A gram or two of sodium lauryl sulfate or other surfactant will improve its action in some cases. This solution should be used with a buret brush.

Dichromate cleaning solution (chromic acid) is a powerful cleaning agent; however, because of its destructive nature upon clothing and upon laboratory furniture, extreme care must be taken when using this mixture. If any of the solution is spilled, it must be cleaned up immediately. Chromic acid solution may be prepared in the laboratory by adding 1 l of concentrated sulfuric acid slowly, with stirring, to a 35-ml saturated sodium dichromate solution. This mixture must be allowed to stand for approximately 15 min in the vessel that is being cleaned and may then be returned to a storage bottle. Following the chromic acid wash, the vessels are rinsed thoroughly with tap water, then with small successive portions of distilled water. The analyst should be cautioned that when chromium is included in the

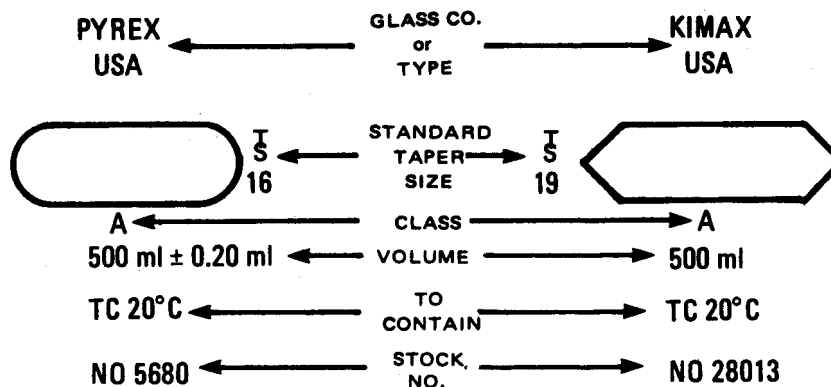

Figure 4-1. Example of markings on glassware.

scheme of analysis, it is imperative that the last traces of dichromate be removed from the apparatus. To this end, a substitute for dichromate cleaning solution, called Nochromix,* is available and may be used to advantage. Fuming nitric acid is another powerful cleaning agent, but is disagreeable to handle. As with dichromate, when the acid becomes dilute, the cleaning mixture is no longer effective. A mixture of concentrated sulfuric and fuming nitric acids is even more efficient but is also hazardous to use. A persistent greasy layer or spot may be removed by acetone or by allowing a warm solution of sodium hydroxide, about 1 g per 50 ml of water, to stand in the vessel for 10 to 15 min; after rinsing with water, dilute hydrochloric acid, and water again, the vessel is usually clean. Alcoholic potassium hydroxide is also effective in removing grease. To dry glass apparatus, rinse with acetone and blow or draw air through it.

4.6 Special Cleaning Requirements

Absorption cells, used in spectrophotometers, should be kept scrupulously clean, free of scratches, fingerprints, smudges, and evaporated film residues. The cells may be cleaned with detergent solutions for removal of organic residues, but should not be soaked for prolonged periods in caustic solutions because of the possibility of etching. Organic solvents may be used to rinse cells in which organic materials have been used. Nitric acid rinses are permissible, but dichromate solutions are not recommended because of the adsorptive properties of dichromate on glass. Rinsing and drying of cells with alcohol or acetone before storage is a preferred practice. Matched cells should be checked to see that they are equivalent by placing portions of the same solution in both cells and taking several readings of the transmittance (T , percent) or optical density (OD) values.

For certain determinations, especially trace metals, the glassware should also be rinsed with a 1:1 nitric acid-water mixture. This operation is followed by thoroughly rinsing with tap water and successive portions of distilled water. This may require as many as 12 to 15 rinses, especially if chromium is being determined. The nitric acid rinse is also especially important if lead is being determined.

Glassware to be used for phosphate determinations should not be washed with detergents containing phosphates. This glassware must be thoroughly rinsed with tap water and distilled water. For ammonia and Kjeldahl nitrogen, the glassware must be rinsed with ammonia-free water. (See ch. 2.)

Glassware to be used in the determination of trace organic constituents in water, such as chlorinated pesticides, should be as free as possible of organic contaminants. A chromic acid wash of at least 15 min is necessary to destroy these organic residues. Rinse thoroughly with tap water and, finally, with distilled water. Glassware may be dried for immediate use by rinsing with redistilled acetone. Otherwise glassware may be oven dried or drip dried. Glassware should be stored immediately after drying to prevent any accumulation of dust and stored inverted or with mouth of glassware covered with foil.

Bottles to be used for the collection of samples for organic analyses should be rinsed successively with chromic acid cleaning solution, tap water, distilled water, and, finally, several times with a redistilled solvent such as acetone, hexane, petroleum ether, or chloroform. Caps are washed with detergent, rinsed with tap water, distilled water, and

* Available from Godax Laboratories, 6 Varick Street, New York, N.Y. 10013.

solvent. Liners are treated in the same way as the bottles and are stored in a sealed container.

4.7 Disposable Glassware

When the risk of washing a pipet for reuse becomes too great, as in the case of use with toxic materials, or when the cost of washing glassware becomes prohibitive, disposable vessels may be the answer, provided they meet the necessary specification. Various types are available including bacteriological, serological, and microdilution pipets. Disposable glassware generally is made of soft glass although plastic vessels and pipets are also available.

4.8 Specialized Glassware

The use of vessels and glassware fitted with standard-taper, ground-glass, and ball-and-socket joints has increased because of certain advantages such as less leakage and fewer freezeups. Standard-taper, interchangeable ground joints save time and trouble in assembling apparatus. They are precision-ground with tested abrasives to insure an accurate fit and freedom from leakage. Ball and socket joints increase flexibility of operation and eliminate the need for exact alignments of apparatus. Symbols and their meaning as applied to standard joints, stoppers, and stopcocks are shown below.

4.8.1 Standard Taper (T)

The symbol T is used to designate interchangeable joints, stoppers, and stopcocks that comply with the requirements of reference 5. All mating parts are finished to a 1:10 taper.

The size of a particular piece appears after the appropriate symbol. Primarily because of greater variety of apparatus equipped with T fittings, a number of different types of identifications are used:

- a. For joints—a two-part number as T 24/40, with 24 being the approximate diameter in millimeters at the large end of the taper and 40 the axial length of taper, also in millimeters
- b. For stopcocks—a single number, as T 2, with 2 mm being the approximate diameter of the hole or holes through the plug
- c. For bottles—a single number, as T 19, with 19 mm being the appropriate diameter at top of neck. However, there are differences in dimensions between the bottle and flask stoppers
- d. For flasks and similar containers—a single number, as T 19, with 19 mm being the appropriate diameter of the opening at top of neck

4.8.2 Spherical Joints (S)

The designation S is for spherical (semiball) joints complying with reference 5. The complete designation of a spherical joint also consists of a two-part number, as 12/2, with 12 being the approximate diameter of the ball and 2 the bore of the ball and the socket, also in millimeters.

4.8.3 Product Standard (S^P)

The symbol S^P is used for stopcocks with Teflon plugs, the mating surfaces being finished to a 1:5 taper. As with S stopcocks, a single number is used. Thus, S^P 2 means a Teflon stopcock with a hole of approximately 2-mm diameter in the plug.

4.9 Fritted Ware

For certain laboratory operations the use of fritted ware for filtration, gas dispersion, absorption, or extractions may be advantageous.

There are six different porosities of fritted ware available, depending on its intended use. Porosity is controlled in manufacture, and disks are individually tested and graded into these classifications. The extra-coarse and coarse porosities are held toward the maximum pore diameter as listed. The medium, fine, very fine, and ultrafine are held toward the minimum pore diameter as listed in table 4-2.

Pore sizes are determined by the method specified in reference 6.

4.9.1 Recommended Procedures for Maximum Filter Life

- a. New Filters. Wash new filters by suction with hot hydrochloric acid, followed by a water rinse.
- b. Pressure Limits. The maximum, safe, differential pressure on a disk is 15 lb/in².
- c. Thermal Shock. Fritted ware has less resistance to thermal shock than nonporous glassware. Hence, excessive, rapid temperature changes and direct exposure to a flame should be avoided. Heating in a furnace to 500°C may be done safely, provided the heating and cooling are gradual. Dry ware may be brought to constant weight by heating at 105°C to 110°C.

Never subject a damp filter of ultrafine porosity to a sudden temperature change. Steam produced in the interior may cause cracking.

Table 4-2
FRITTED-WARE POROSITY

Porosity Grade	Designation	Pore Size (μm)	Principal Uses
Extra Coarse	EC	170-220	Coarse filtration; gas dispersion, washing, and absorption
Coarse	C	40-60	Coarse filtration; gas dispersion, washing, and absorption
Medium	M	10-15	Filtration and extraction
Fine	F	4-5.5	Filtration and extraction
Very Fine	VF	2-2.5	General bacterial filtration
Ultrafine	UF	0.9-1.4	General bacterial filtration

4.9.2 Cleaning of Used Filters

In many cases, precipitates can be removed by rinsing with water, passed through from the underside, with the pressure not exceeding 15 lb/in². The suggestions that follow will be helpful in dealing with material that will not be removed by such a reverse water-wash:

<i>Material</i>	<i>Removal Agent</i>
Albumen	Hot ammonia or hydrochloric acid
Aluminous and siliceous residues . .	Hydrofluoric acid (2 percent) followed by concentrated sulfuric acid; rinse immediately with water until no trace of acid can be detected.
Copper or iron oxides	Hot hydrochloric acid plus potassium chlorate
Fatty materials	Carbon tetrachloride
Mercuric sulfide	Hot aqua regia
Organic matter	Hot, concentrated cleaning solution, or hot, concentrated sulfuric acid with a few drops of sodium nitrite
Silver chloride	Ammonium or sodium hyposulfite

4.10 References

1. Methods for Chemical Analysis of Water and Wastes, U.S. EPA, Office of Research and Development, EMSL (1978).
2. Hughes, J. C., Testing of Glass Volumetric Apparatus, NBS Circular 602, National Bureau of Standards (1959).
3. Peffer, E. L., and Mulligan, G. C., Testing of Glass Volumetric Apparatus, NBS Circular 434, National Bureau of Standards (1941).
4. Willard, H. H., and Furman, N. H., Elementary Quantitative Analysis-Theory and Practice, D. Van Nostrand Co., Inc., New York (1947).
5. Interchangeable Ground Glass Joints, Commercial Standard CS-21-30, National Bureau of Standards (Aug. 25, 1930).
6. Maximum Pore Diameter and Permeability of Rigid Porous Filters for Laboratory Use, E-128, American Society for Testing and Materials, Philadelphia (1968).

Chapter 5

REAGENTS, SOLVENTS, AND GASES

5.1 Introduction

The objective of this chapter is to provide general information and suggestions that will serve to keep the analyst conscious of his responsibilities in analytical quality control, as they relate to reagents, solvents, and gases. While the material presented here will assist the analyst in producing high-quality data, it is by no means complete. It is incumbent on the analyst to obtain details of special precautions required to insure proper selection, preparation, and storage of reagents, solvents, and gases from the descriptions of individual methods.

5.2 Reagent Quality

Chemical reagents, solvents, and gases are available in a wide variety of grades of purity, ranging from technical grade to various ultrapure grades. The purity of these materials required in analytical chemistry varies with the type of analysis. The parameter being measured and the sensitivity and specificity of the detection system are important factors in determining the purity of the reagents required. For many analyses, including most inorganic analyses, analytical reagent grade is satisfactory. Other analyses, such as trace organic and radiological, frequently require special ultrapure reagents, solvents, and gases. In methods where the purity of reagents is not specified it is intended that analytical reagent grade be used. Reagents of lesser purity than that specified by the method should not be used. The labels on the container should be checked and the contents examined to verify that the purity of the reagents meets the needs of the particular method involved. The quality of reagents, solvents, and gases required for the various classes of analyses – inorganic, metals, radiological, and organic – are discussed in this section.

Reagents must always be prepared and standardized with the utmost of care and technique against reliable primary standards. They must be restandardized or prepared fresh as often as required by their stability. Stock and working standard solutions must be checked regularly for signs of deterioration; e.g., discoloration, formation of precipitates, and change of concentration. Standard solutions should be properly labeled as to compound, concentration, solvent, date, and preparers

Primary standards must be obtained from a reliable source, pretreated (e.g., dried, under specified conditions), accurately prepared in calibrated volumetric glassware, and stored in containers that will not alter the reagent. A large number of primary standards are available from the National Bureau of Standards (NBS). A complete listing of available standards is given in reference 1. Primary standards may also be obtained from many chemical supply companies. Suppliers for special quality reagents, solvents, and gases are noted in later discussions of the various classes of analyses. Reagents and solvents of all grades are available from many chemical supply houses.

There is some confusion among chemists as to the definition of the terms “Analytical Reagent Grade,” “Reagent Grade,” and “ACS Analytical Reagent Grade.” A review of the literature and chemical supply catalogs indicates that the three terms are synonymous. Hereafter, in this document, the term “Analytical Reagent Grade” (AR) will be used. It is

intended that AR-grade chemicals and solvents shall conform to the current specifications of the Committee on Analytical Reagents of the American Chemical Society (2).

References 3 through 5 devote several chapters to problems related to preparation, standardization, and storage of reagents. The information provided therein is particularly appropriate to inorganic determinations. The type of volumetric glassware to be used, the effect of certain reagents on glassware, the effect of temperature on volumetric measurements, purity of reagents, absorption of gases and water vapor from the air, standardization of solutions, instability, and the need for frequent standardization of certain reagents are among the topics discussed. It is recommended that the analyst become thoroughly familiar with these publications.

5.2.1 General Inorganic Analyses

In general, AR-grade reagents and solvents are satisfactory for inorganic analyses. Primary standard reagents must, of course, be used for standardizing all volumetric solutions. Commercially prepared reagents and standard solutions are very convenient and may be used when it is demonstrated that they meet the method requirements. All prepared reagents must be checked for accuracy.

The individual methods specify the reagents that require frequent standardization, or other special treatment, and the analyst must follow through with these essential operations. To avoid waste, the analyst should prepare a limited volume of such reagents, depending on the quantity required over a given period of time. Examples and brief discussions of the kind of problems that occur are given in section 5.3.

As far as possible, distilled water used for preparation of reagent solutions must be free of measurable amounts of the constituent to be determined. Special requirements for distilled water are given in chapter 3 of this manual and in individual method descriptions.

Compressed gases, such as oxygen and nitrogen, used for total organic carbon determination may be of commercial grade.

5.2.2 Metals Analyses

All standards used for atomic absorption and emission spectroscopy should be of spectroquality. It is recommended that other reagents and solvents also be of spectroquality, although AR grade is sometimes satisfactory. Standards may be prepared by the analyst in the laboratory, or spectrographically standardized materials may be purchased commercially. Standards required for determination of metals in water are not generally available from the National Bureau of Standards.

Analytical-reagent-grade nitric and hydrochloric acids must be specially prepared by distillation in borosilicate glass and diluted with deionized distilled water. All other reagents and standards are also prepared in deionized water.

In general, fuel and oxidant gases used for atomic absorption can be of commercial grade. Air supplied by an ordinary laboratory compressor is quite satisfactory, if adequate pressure is maintained and necessary precautions are taken to filter oil, water, and possible trace metals from the line. For certain determinations such as aluminum, AR-grade nitrous oxide is required.

5.2.3 Radiological Analyses

The great sensitivity of radioactive counting instruments requires that scintillation-grade reagents and solvents, or equivalent, be used for all radioactivity determinations. Some of the reagents, for example, strontium carbonate and yttrium oxide carriers used for the determination of strontium-90 and yttrium-90, must be stable, that is, free of radioactivity. Barium sulfate, used for coprecipitation of radium, must be free from all traces of radium. These reagents and solvents are commercially available from chemical supply houses.

Calibrated standard sources of specific radioactive materials with known count and date of counting are available from various suppliers. No single company supplies all standards.

Gases used for radioactive counting must be of high purity and extra dry. Gases such as helium and air are aged for about 30 days to allow radioactive background to decay. All gases are checked for background before use. Some cylinders contain inherent radioactivity that is imparted to the gas. When this background is above normal, the gas should not be used for radioactivity determinations.

5.2.4 Organic Chemical Analyses

The minimum purity of reagents that can be used for organic analyses is AR grade. Reference-grade standards should be used whenever available. Special note should be taken of the assay of standard materials. Owing to the great sensitivity (nanogram and subnanogram quantities) of gas chromatography (GC), which is often used to quantitate organic results, much greater purity is frequently required (6). The specificity of some GC detectors requires that reagents and solvents be free of certain classes of compounds. For example, analyses by electron capture require that reagents and solvents be free of electronegative materials that would interfere with the determination of specific compounds in the sample. Similarly, use of the flame photometric detector requires that reagents and solvents be free from sulfur and phosphorus interference. Pesticide-quality solvents, available from several sources, are required when doing low-level work. AR-grade solvents are permissible when analyzing industrial waste samples.

However, the contents of each container must be checked to assure its suitability for the analyses. Similarly, all analytical reagents and other chemicals must also be checked routinely.

The quality of gases required for GC determinations varies somewhat with the type of detector. In general, the compressed gases are a prepurified dry grade. Grade A helium from the U.S. Bureau of Mines has always been satisfactory. The Dohrmann nitrogen detection system requires the use of ultrapure hydrogen for satisfactory results. Argon-methane used for electron-capture work should be oxygen free and should have an oxygen trap in the supply line. The use of molecular-sieve, carrier-gas filters and drying tubes is required on combustion gases and is recommended for use on all other gases. It is recommended that the analyst familiarize himself with an article by Burke (7) on practical aspects of GC.

All reagents, solvents, and adsorbents used for thin-layer chromatography must be checked to be certain that there are no impurities present that will react with the chromogenic reagent or otherwise interfere with subsequent qualitative or quantitative determinations. Glass-backed layers prepared in the laboratory or precoated layers supplied by a manufacturer may be used; however, precoated layers are more difficult to scrape. It is

recommended, therefore, that layers prepared in the laboratory be used when zones are to be scraped to recover isolated compounds. Plastic-backed layers are generally unsatisfactory for this type of analysis.

Adsorbents most commonly used for column chromatographic cleanup of sample extracts are Florisil,* silica gel, and alumina. These must be preactivated according to the method specifications and checked for interfering constituents.

5.3 Elimination of Determinate Errors

To produce high-quality analytical data, determinate errors must be eliminated or at least minimized. For purposes of this discussion, we assume that a competent analyst and reliable equipment in optimum operating condition are available. Thus, determinate errors that might result from an inexperienced or careless analyst and poor equipment are eliminated. The remaining sources of error are the reagents, solvents, and gases that are used throughout the analyses. The quality of these materials, even though they are AR grade or better, may vary from one source to another, from one lot to another, and even within the same lot. Therefore, the analyst must predetermine that all of these materials are free of interfering substances under the conditions of the analyses. To do this he must have a regular check program. Materials that do not meet requirements are replaced or purified so that they can be used.

5.3.1 Reagent Blank

The first step the analyst must take is to determine the background or blank of each of the reagents and solvents used in a given method of analysis. The conditions for determining the blank must be identical to those used throughout the analysis, including the detection system. If the reagents and solvents contain substances that interfere with a particular analysis, they should be treated so that they can be used, or satisfactory reagents and solvents must be found.

5.3.2 Method Blank

After determining the individual reagent or solvent blanks, the analyst must determine the method blank to see if the cumulative blank interferes with the analyses. The method blank is determined by following the procedure step by step, including all of the reagents and solvents, in the quantity required by the method. If the cumulative blank interferes with the determination, steps must be taken to eliminate or reduce the interference to a level that will permit this combination of solvents and reagents to be used. If the blank cannot be eliminated, the magnitude of the interference must be considered when calculating the concentration of specific constituents in the samples being analyzed.

A method blank should be determined whenever an analysis is made. The number of blanks to be run is determined by the method of analysis and the number of samples being analyzed at a given time. In some methods, such as the AutoAnalyzer procedures, the method blank is automatically and continuously compensated for because a continuous flow of the reagents passes through the detector. In other procedures, such as the gas chromatographic determination of pesticides, a method blank is run with each series of samples analyzed. Usually this is one blank for every nine samples.

*Trademark of Floridin Co.

5.3.3 Elimination of Interferences and Other Sources of Error

Procedures for eliminating or at least minimizing impurities that produce specific interferences or high general background vary with the reagent and method involved. These procedures may include the following: recrystallization, precipitation, distillation, washing with an appropriate solvent, or a combination of these. Examples of procedures used for various types of analyses are given below. For complete information, the analyst should consult the individual methods.

5.3.3.1 General Inorganic Analyses

Analytical-reagent-grade chemicals and solvents usually present no interference problems in inorganic analyses. However, some reagents do not always meet methods requirements. An example is potassium persulfate used in phosphorus and nitrogen determinations. This reagent is frequently contaminated with ammonia. Therefore, it is routinely purified by passing air through a heated water solution of the reagent. The purified potassium persulfate is recovered by recrystallization.

A problem more commonly encountered in inorganic analyses is the rapid deterioration of the standard reagents and other ingredients. To minimize or eliminate this problem, some reagents, for example, ferrous ammonium sulfate, must be standardized daily. Others, such as sodium thiosulfate used for dissolved oxygen determination, may require a substitute reagent such as phenylarsine oxide. Solid phenol, which readily oxidizes and acquires a reddish color, can be purified by distillation. Starch indicator used for iodometric titrations may be prepared for each use or preserved by refrigeration or by addition of zinc chloride or other suitable compounds.

5.3.3.2 Metals Analyses

In general, spectrograde chemicals, solvents, and gases present no interference problems in atomic absorption or emission spectrographic determinations. However, standards that do not meet the requirements of the method are sometimes obtained. Ordinarily, no effort is made to purify them. They are simply replaced by new reagents of sufficient purity. Some reagents may form precipitates on standing. Such reagents will reduce the accuracy of quantitative analyses and should not be used.

5.3.3.3 Radiological Analyses

In general, reagents that do not meet the purity requirements for radiological determinations are replaced with reagents that are satisfactory. However, in some instances (for example, barium sulfate used for coprecipitation of radium) it may be necessary to perform repeated recrystallization to remove all forms of radium, and reduce the background count to a usable level. In some instances, solvents that do not meet requirements may be distilled to produce adequate purity. In some cases, gases having background counts may be usable after aging as described earlier. If not, they should be replaced with gases that are satisfactory.

5.3.3.4 Organic Analyses

Many AR-grade chemicals and solvents, and at times pesticide-quality solvents, do not meet the specifications required for the determination of specific organic compounds. Impurities

that are considered trace, or insignificant, for many analytical uses are often present in greater quantities than the organic constituents being measured. Coupled with the several-hundred-fold concentration of the sample extract that is usually required, such impurities can cause very significant interferences in trace organic analyses. Reagents and solvents found to be unsatisfactory, under the conditions of the analyses, must be replaced or cleaned up so that they are usable. Some useful cleanup procedures are –

- a. Washing the inorganic reagents with each solvent that the reagent contacts during the analysis
- b. Washing the adsorbents, such as silica gel G and Florisil, with the solvents that are used for a specified column or thin-layer chromatographic procedure, or reactivating the Florisil by firing to 630°C
- c. Preextracting distilled water with solvents used for the particular analysis involved
- d. Preextracting aqueous reagent solutions with the solvents involved
- e. Redistilling solvents in all-glass systems using an efficient fractionating column
- f. Recrystallizing reagents and dyes used in calorimetric or thin-layer determinations

If the reagents and solvents thus produced are not of sufficient purity, they should be replaced.

Dirty gases (quality less than specified) are particularly troublesome in gas chromatographic analyses. They may reduce the sensitivity of the detector, and produce a high or noisy baseline. If this occurs, the cylinder should be replaced immediately. Similarly, if cylinders of compressed gases are completely emptied in use, the end volumes of the gas may produce a similar and often more severe effect. Oils and water may get into the system and foul the detector. When this occurs the system must be dismantled and cleaned. Overhaul of the detector may be required. To reduce chances of this, it is recommended that all gas cylinders be replaced when the pressure falls to 100 to 200 psi. Filter driers are of little help in coping with this type of contamination.

5.3.4 Storing and Maintaining Quality of Reagents and Solvents

Having performed the tasks of selecting, preparing, and verifying the suitability of reagents, solvents, and gases, the analyst must properly store them to prevent contamination and deterioration prior to their use. Borosilicate glass bottles with ground-glass stoppers are recommended for most standard solutions and solvents. Plastic containers such as polyethylene are recommended for alkaline solutions. Plastic containers must not be used for reagents or solvents intended for organic analyses. However, plastic containers may be used for reagents not involved with organic analyses if they maintain a constant volume, and if it is demonstrated that they do not produce interferences and do not absorb constituents of interest. It is important that all containers be properly cleaned and stored prior to use. (Refer to ch. 4 for details.)

Standard reagents and solvents must always be stored according to the manufacturer's directions. Reagents or solvents that are sensitive to the light should be stored in dark bottles and in a cool, dark place. It is particularly important to store materials used for

radiological determinations in dark bottles, because photoluminescence will produce high background if light-sensitive detectors are used for counting. Some reagents require refrigeration.

Adsorbents for thin-layer and column chromatography are stored in the containers that they are supplied in, or according to the requirements of individual methods. When new stock solutions are necessary, dilutions of the old and new standard should be compared to determine their accuracy.

The analyst should pay particular attention to the stability of the standard reagents. Standards should not be kept longer than recommended by the manufacturer or in the method. Some standards are susceptible to changes in normality because of absorption of gases or water vapor from the air. Provisions for minimizing this effect are given in reference 4.

The concentration of the standards will change as a result of evaporation of solvent. This is especially true of standards prepared in volatile organic solvents. Therefore, the reagent bottles should be kept stoppered, except when actually in use. The chemical composition of certain standards may change on standing. Certain pesticides, for instance, will degrade if prepared in acetone that contains small quantities of water. Thus, it is essential that working standards be frequently checked to determine changes in concentration or composition. Stock solutions should be checked before preparing new working standards from them.

5.4 References

1. Catalog of Standard Reference Materials, NBS Special Publication 260, National Bureau of Standards (June 1975).
2. "Reagent Chemicals," American Chemical Society Specifications, 5th Edition, American Chemical Society, Washington, D.C. (1974).
3. Manual on Industrial Water and Industrial Waste Water, 2nd Edition, ASTM Special Publication 148-H, American Society for Testing and Materials (1965), p. 869.
4. "Standard Methods for Preparation, Standardization, and Storage of Standard Solutions for Chemical Analysis," from Part 31 of 1976 Book of ASTM Standards, American Society for Testing and Materials, Philadelphia (1977).
5. Standard Methods for the Examination of Water and Wastewater, 13th Edition, American Public Health Association, New York (1971).
6. Methods for Organic Pesticides in Water and Wastewater, U.S. EPA, Environmental Research Center, Cincinnati (1971).
7. Burke, J., "Gas Chromatography for Pesticide Residue Analysis; Some Practical Aspects," J. Assoc. Off. Anal. Chem., 48, 1037 (1965).

QUALITY CONTROL FOR ANALYTICAL PERFORMANCE

6.1 Introduction

Previous chapters discussed basic elements of quality control (QC) pertaining to laboratory services, instrumentation, glassware, reagents, solvents, and gases; the reader should refer to the appropriate sections to determine necessary specifications and requirements for QC. Assuming that these basic variables are under QC, that approved methods are being used, and that the complete system is initially under QC, valid precision and accuracy data must initially be developed for each method and analyst. Then, to insure that valid data continue to be produced, systematic daily checks must show that the test results remain reproducible, and that the methodology is actually measuring the quantity in each sample. In addition, QC must begin with sample collection and must not end until the resulting data have been reported. QC of analytical performance within the laboratory is thus but one vital link in the dissemination of valid data to the public. Understanding and conscientious use of QC among all field sampling personnel, analytical personnel, and management personnel is imperative. Technical approaches are discussed in the following sections.

6.2 The Industrial Approach to QC

In the 1920's, Dr. Walter A. Shewhart of Bell Telephone Laboratories, Inc. developed the theory of control charts as a basic method for evaluating the quality of products from manufacturing processes. His book (1) on statistical QC grew out of this original work. Later, acceptance of his concepts and related statistical techniques within industry led to refined, quantitative evaluations of product quality in manufacturing. Dr. Shewhart's work on production processes assumed a uniform product manufactured in large numbers and inspected on a continuous basis through the periodic analysis of samples of n production units. The resulting data, X_1, X_2, \dots, X_n , were then used to estimate precision, as the standard deviation S or range R , and accuracy, as the arithmetic mean \bar{X} . These statistics were calculated as follows:

$$S = \sqrt{\frac{\sum_{i=1}^n X_i^2 - \left(\sum_{i=1}^n X_i\right)^2 / n}{n - 1}}$$

R the largest of the X_i – the smallest of the X_i

$$\bar{X} = \frac{\sum_{i=1}^n X_i}{n}$$

These statistics were evaluated by plotting them on control charts developed from similar statistics taken while the process was under properly controlled operation. The elements common to such control charts are represented in figure 6-1. They include an expected value (the central line) and an acceptable range of occurrence (the region between upper and lower control limits).

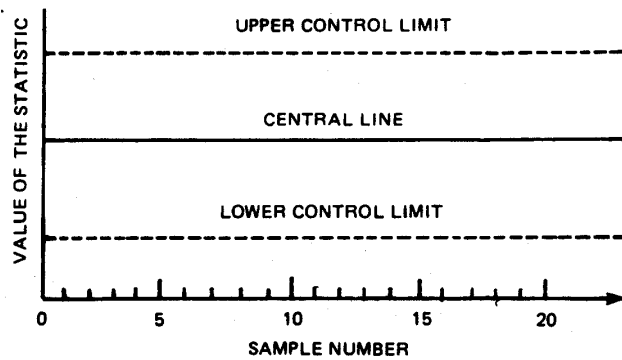

Figure 6- 1. Essentials of a control chart.

There are many reference sources available that discuss in great detail the classic Shewhart control charts and related statistics that have since been developed for specific industrial applications (2-4). In addition, many authors have discussed applications of a related type of control chart called a cumulative-summation (cusum) chart (2,4). Rather than evaluating each sample independently, the cusum chart evaluates the cumulative trend of the statistics from a series of samples. Because each successive point is based upon a cumulative data trend, cusum charts are often considered more effective than control charts in recognizing process changes and, therefore, may minimize losses from production of unacceptable units; however, cusum charts require the more difficult calculations, and optimally designed Shewhart techniques have been found to be almost as effective (2,4), so there is no universal agreement on the choice between them.

6.3 Applying Control Charts in Environmental Laboratories

In industrial applications, separate control charts are recommended for each product, each machine, and each operator. Analogous system variables in an environmental laboratory are the parameter, the instrument, and the analyst. However, environmental laboratories routinely have to contend with a variable that has no industrial counterpart—the true concentration level of the investigated parameter, which may vary considerably among samples. Unfortunately, the statistics that work well for industry are sensitive to the variability in true concentration that is common in environmental analysis; e.g., the classic \bar{X} and R statistic values increase substantially as concentration increases. This variability in true concentration means there are no expected values for randomly selected samples, so that the accuracy of testing methodology must be evaluated indirectly through the recovery of standards and spikes. As a result, it has been difficult for environmental laboratories to satisfactorily apply industrial QC techniques.

There are two possible approaches to the solution of the problem of variation in the true concentration level; either use of a statistic that is not sensitive to this variation or application of the industrial techniques within restricted concentration ranges. Obviously, the former should be preferred because it actually solves the problem and does not require the development and maintenance of a series of charts for each parameter.

6.3.1 Quality Control Charts for Accuracy

Two replacements for the Shewhart \bar{X} control chart have been suggested for evaluating the recovery of a series of different standards or spikes. One of these, a cusum chart using the

square of the difference between the observed and true values, is described in an EPA Region VI QC manual (5). The other alternative uses the classic Shewhart technique to evaluate the percent recovery instead of \bar{X} . It is recommended that the percent recovery be calculated as

$$P = 100 \frac{\text{observed}}{\text{known}}$$

for standards, or

$$P = 100 \frac{\text{observed} - \text{background}}{\text{spike}}$$

for recovery of spikes into natural water backgrounds. An example of the linear relationship between percent recovery and the known concentration of standards and spikes is demonstrated in the accuracy plots of a recent EPA method study report on analysis of mercury (6). Both approaches are being used on a daily basis by various environmental laboratories.

The data in table 6-1 were used in the EPA Region VI manual (5) to illustrate the development of a cusum chart. The actual data have been reordered here to appear in ascending order of the known values. Note that the mean and the range of the d_i^2 values increase with increasing concentration level, and this violates a basic premise for acceptable control chart statistics. Because the percent recovery data do not show any such trend, it is the recommended control chart statistic for controlling accuracy.

From the data in table 6-1, a Shewhart control chart for percent recovery can be calculated in the following way:

Average percent recovery

$$\begin{aligned} \bar{P} &= \frac{\sum_{i=1}^{23} P_i}{23} \\ &= \frac{2,310}{23} \\ &= 100.4 \end{aligned}$$

The standard deviation for percent recovery

$$S_p = \sqrt{\frac{\sum_{i=1}^{23} P_i^2 - \left(\sum_{i=1}^{23} P_i\right)^2 / 23}{22}}$$

$$\begin{aligned}
&= \sqrt{\frac{234,074 - (2,310)^2 / 23}{22}} \\
&= \sqrt{94.0751} \\
&= 9.70
\end{aligned}$$

Therefore, the upper control limit becomes the following:

$$\begin{aligned}
\text{UCL} &= \bar{P} + 3S_p \\
&= 100.4 + 3(9.70) \\
&= 129.5
\end{aligned}$$

Table 6-1
ANALYSIS¹ OF TOTAL PHOSPHATE-PHOSPHORUS STANDARDS, IN mg/l
TOTAL PO₄ -P

Point	Known	Obtained	Difference d_i	d_i^2	Percent Recovery	P_i^2
1	0.34	0.33	0.01	0.0001	97	9,409
2	0.34	0.34	0.00	0.0000	100	10,000
3	0.40	0.40	0.00	0.0000	100	10,000
4	0.49	0.49	0.00	0.0000	100	10,000
5	0.49	0.49	0.00	0.0000	100	10,000
6	0.49	0.63	-0.14	0.0196	129	16,641
7	0.50	0.47	0.03	0.0009	94	8,836
8	0.50	0.53	-0.03	0.0009	106	11,236
9	0.50	0.56	-0.06	0.0036	112	12,544
10	0.52	0.59	-0.07	0.0049	113	12,769
11	0.66	0.70	-0.04	0.0016	106	11,236
12	0.66	0.60	0.06	0.0036	91	8,281
13	0.67	0.65	0.02	0.0004	97	9,409
14	0.68	0.65	0.03	0.0009	96	9,216
15	0.83	0.80	0.03	0.0009	96	9,216
16	0.98	0.75	0.23	0.0529	77	5,929
17	1.3	1.2	0.10	0.0100	92	8,464
18	1.3	1.3	0.00	0.0000	100	10,000
19	1.6	1.7	-0.10	0.0100	106	11,236
20	2.3	2.3	0.00	0.0000	100	10,000
21	2.3	2.4	-0.10	0.0100	104	10,816
22	3.3	3.3	0.00	0.0000	100	10,000
23	4.9	4.6	0.30	0.0900	94	8,836
Totals					2,310	234,074

¹Using a calorimetric method with persulfate digestion.

and the lower control limit becomes

$$\begin{aligned} \text{LCL} &= 100.4 - 29.1 \\ &= 71.3 \end{aligned}$$

The completed control chart is shown in figure 6-2.

Following normal procedures, the control chart must indicate the conditions under which it was developed; i.e., laboratory name, parameter, method of analysis, date of preparation, and any other information unique to the initializing data, such as range of concentration and identification of analyst(s). A control chart is not generally applicable under other conditions.

To verify the control chart, the initializing data should be checked to be sure that none of the values exceeds these new control limits. In addition, if its distribution is proper, about 68 percent of the initializing data should fall within the interval $\bar{P} \pm S_p$. It has been suggested that the control chart is not valid if less than 50 percent of the initializing data falls within this interval.

In applying the control chart, either of the following two conditions would indicate an out-of-control situation:

- a. Any point beyond the control limits
- b. Seven successive points on the same side of the value \bar{P} of the central line

When an out-of-control situation occurs, analyses must be stopped until the problem has been identified and resolved, after which the frequency should be increased for the next few percent-recovery QC checks. The problem and its solution must be documented, and all analyses since the last in-control point must be repeated or discarded.

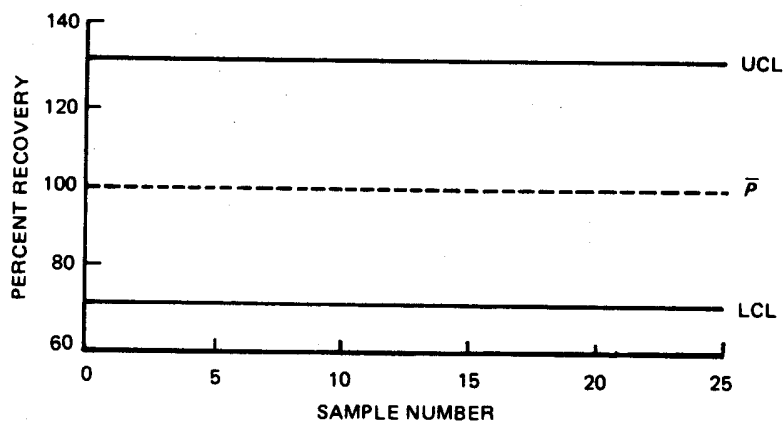

Figure 6-2. Shewhart control chart for percent recovery data.

A final note of caution regarding use of a single percent-recovery P control chart over a broad concentration range is necessary. As noted earlier for the analysis of mercury, a good linear relationship of the form

$$\bar{X} = P (\text{known concentration}) + K$$

where K is a constant, seems appropriate for many parameters. However, to justify use of a single percent-recovery control chart, K must be small enough relative to the P (known concentration) term that it has little or no practical effect upon the value of \bar{X} . This will usually be true for moderate or high concentration levels, but may not be true at very low concentration levels. As a result, for some parameters it may be necessary to develop a separate percent-recovery or Shewhart \bar{X} chart for each standardized low concentration level sample.

6.3.2 Quality Control Charts for Precision

Because the characteristics of the range statistic change as concentration changes, two alternatives to Shewhart's R chart have been used in environmental laboratories to evaluate the precision of routine sample analyses.

One alternative is a cusum chart using the sum of the squared difference between duplicate determinations on randomly selected routine samples (5). Because the range R for duplicate analyses is equal to the difference between them, the cusum statistic equals the sum of squared ranges $\sum R^2$. However, if R changes significantly as concentration level changes, then R^2 is affected even more and, therefore, is *not* as good a criterion for judging whether precision of the system is within acceptable limits.

The other alternative uses a chart similar to the R chart, but the chart statistic is either the percent relative standard deviation ($100S/\bar{X}$), the coefficient of variation (CV or S/\bar{X}) or the industrial statistic I . For the duplicate determinations A and B , I equals the absolute value of their difference divided by their sum, or $|A - B|/(A + B)$, and can be shown to be equivalent to the other two statistics:

$$\begin{aligned} 100(\text{CV}) &= 100 \frac{S}{\bar{X}} \\ &= 100 \frac{R / \sqrt{2}}{(A + B) / 2} \\ &= 100 \frac{2}{\sqrt{2}} \frac{R}{(A + B)} \\ &= \frac{200}{\sqrt{2}} \frac{|A - B|}{(A + B)} \\ &= \frac{200I}{\sqrt{2}} \end{aligned}$$

For the sake of computational ease, I seems to be a logical alternative to R .

The next concern is whether *I* is independent of changes in concentration level. Based upon experience with duplicates on routine samples taken during the last 2 years by EPA Region VII, *I* appears to decrease substantially as concentration increases. In recognition of this possible dependency, control charts for *I* should only be developed from and applied to results within a limited concentration range. Note that control charts for *R* could be applied under similar limitations.

As an illustration of the concentration dependency of these precision statistics, table 6-2 provides estimates of *R* and *I* for different concentration ranges of three parameters. These parameters were selected because approximately 100 sets of duplicates were available that were well distributed over a reasonably broad concentration range. The ranges for the sum of duplicates *A + B* used in table 6-2 were selected because they were convenient and the data tended to be well distributed among them. Data judged to be out of control were discarded before any calculations were made.

Table 6-2 indicates the concentration dependence of both the range *R* and the industrial statistic *I* for these three parameters. Because *I* is not independent of concentration and is

Table 6-2
ESTIMATES OF THE RANGE $R = |A - B|$ AND THE INDUSTRIAL STATISTIC $[I = |A - B|/(A + B)]$ OF THREE DIFFERENT PARAMETERS FOR VARIOUS CONCENTRATION RANGES¹

Parameter	Range of A+B	No. of Sets of Duplicates	² A + B	² R	² I
BOD, 5-day (mg/l)	2 to <20	21	11.7	1.04	0.0888
	20 to <50	30	35.2	1.94	0.0552
	50 to <100	27	72.2	3.33	0.0462
	100 to <300	29	204.1	6.52	0.0319
	300 to <600	17	394.4	11.1	0.0282
	600 to <2,000	12	1,041	12.1	0.0116
	2,000 up	3	6,683	177	0.0264
Chromium (Mg/l)	10 to <20	32	12.3	0.32	0.0306
	20 to <50	15	33.4	0.57	0.0170
	50 to <100	16	72.4	1.12	0.0155
	100 to <300	15	170.3	3.80	0.0223
	300 to <1,000	8	480.3	5.25	0.0109
	1,000 up	5	6,340	76.0	0.0120
Copper (Mg/l)	10 to <30	16	22.2	0.93	0.0617
	30 to <50	23	38.2	1.35	0.0368
	50 to <100	21	70.8	1.14	0.0169
	100 to <200	26	131.9	2.33	0.0177
	200 to <400	10	268.0	2.81	0.0105
	400 up	3	702.0	4.56	0.0065

¹From EPA Surveillance and Analysis Laboratory, Region VII.

²Average values.

Table 6-3
SHEWHART UPPER CONTROL LIMITS (UCL) AND CRITICAL RANGE R_c VALUES FOR THE DIFFERENCES BETWEEN DUPLICATE ANALYSES WITHIN SPECIFIC CONCENTRATION RANGES FOR THREE PARAMETERS¹

Parameter	Concentration Range ²	UCL	R_c
BOD, 5-day (mg/l)	1 to <10	3.40	3.5
	10 to <25	6.34	6
	25 to <50	10.9	11
	50 to <150	21.3	21
	150 to <300	36.3	36
	300 to <1,000	39.6	³ 40
	1,000 up	579	³ 579
Chromium (Mg/l)	5 to <10	1.05	1
	10 to <25	1.86	2
	25 to <50	3.66	4
	50 to <150	12.4	12
	150 to <500	17.2	³ 17
	500 up	249	³ 249
Copper (µg/l)	5 to <15	3.04	3
	15 to <25	4.41	4
	25 to <50	3.73	5
	50 to <100	7.62	8
	100 to <200	9.19	³ 9
	200 up	14.9	³ 15

¹From EPA Surveillance and Analysis Laboratory, Region VII.

²Equal to half of the range of $A + B$ given in table 6-2.

³Based on fewer than 15 sets of duplicate analyses.

more difficult to calculate and develop control charts for, the use of R charts for a series of sequential concentration ranges for each parameter seems practical. However, because the primary concern when using any range chart is whether the upper control limit has been exceeded, an even more practical approach would be to develop a table of these limits for all concentration levels of each parameter. As an example, table 6-3 contains the calculated Shewhart upper control limits for the range R from duplicate analyses within the various concentration levels for the three parameters in table 6-2. These limits were calculated, as usual, from the Shewhart factor D_4 for ranges based upon duplicate analyses and the appropriate average value of the range R given in table 6-2. For example, the UCL for 25 to 50 mg/l of BOD was calculated as follows:

$$\begin{aligned}
 \text{UCL} &= D_4 R \\
 &= 3.27(3.33) \\
 &= 10.9
 \end{aligned}$$

Table 6-3 also contains a critical range R_c column. Because the data from EPA Region VII were almost always whole units with only a very occasional half unit reported, the R_c value is the UCL value rounded to the nearest whole unit at higher concentration levels and to the nearest half unit for the lowest concentration level. However, there is an exception to this rule among the low-concentration R_c values for copper that demonstrates an advantage beyond the simplicity of using such tables. The UCL value for copper at 25 to 50 $\mu\text{g/l}$ is inconsistent with the UCL values for adjacent concentration levels, and the R_c value has been adjusted to resolve this inconsistency. Without the table, such inconsistencies could very easily go unnoticed.

The examples in table 64 illustrate how to use the R_c values in table 6-3. This technique, consisting of the development and use of a table of critical-range R_c values at different concentration levels, is recommended to control precision. Normal control chart procedures should be followed as in section 6.3.1 regarding identification and verification of the table. The table should be updated periodically as additional, or more current, data become available, or whenever the basic analytical system undergoes a major change. If any difference between duplicate analyses exceeds the critical-range value for the appropriate concentration level, then analyses must be stopped until the problem is identified and resolved, and the frequency should be increased for the next few precision checks. After resolution, the problem and its solution must be documented, and all analyses since the last in-control check must be repeated or discarded.

6.4 Recommended Laboratory Quality Assurance Program

A minimum laboratory quality assurance program should include control procedures for each parameter as described in the following sections.

6.4.1 Standard Curves

A new standard curve should be established with each new batch of reagents, using at least seven concentration levels.

6.4.2 Quality Control Checks for Each Analytical Run

With each batch of analyses, the following tests should be run:

- a. One blank on water and reagents

Table 6-4
CRITICAL RANGE VALUES FOR VARYING CONCENTRATION
LEVELS

Parameter	Duplicates	R	R_c	$R \leq R_c$	Condition of System
BOD (mg/l)	20 and 24	4	6	Yes	Normal
Chromium ($\mu\text{g/l}$)	60 and 75	15	12	No	Out-of-control
Copper ($\mu\text{g/l}$)	46 and 51	5	15	Yes	Normal

¹This R_c value is used because $(46 + 51)/2 = 48.5$, which is between 25 and 50.

- b. One midpoint standard
- c. One spike to determine recovery
- d. One set of duplicate analysis

The results from b through d should be compared with previous in-control data by using the appropriate technique recommended in section 6.3.

6.4.3 Interlaboratory QC

An interlaboratory QC program would require each laboratory to do the following:

- a. Analyze reference-type samples to provide independent checks on the analytical system. These may be available from EPA as QC samples, from the National Bureau of Standards as standard reference materials, or from commercial sources. If performance limits are not provided, the results should fall within the routine limits of each laboratory for a standard at a level comparable to the specified true value.
- b. Participate in performance evaluation and method studies as available from EPA, from the American Society for Testing and Materials, and from other agencies.

6.5 Outline of a Comprehensive Quality Assurance Program

In the following discussion the symbols used represent the results of analysis according to the scheme:

- A_1 = first replicate of sample A
- A_2 = second replicate of sample A
- B = sample taken simultaneously with sample A
- B_{SF} = field spike into sample B
- B_{SL} = laboratory spike into sample B
- D_F = field spike into distilled water
- D_L = laboratory spike into distilled water
- T = true value for all spikes

The laboratory spikes B_{SL} and D_L are the only analyses that may not be necessary. All other analyses *must* be done simultaneously.

6.5.1 Steps for the Field Personnel

A comprehensive quality assurance program would include the following steps for each parameter in the monitoring study:

- a. Take independent simultaneous samples A and B at the same sampling point. Depending on the parameter, this might involve side-by-side grab samples or composite samplers mounted in parallel.

- b. Split sample A into the equal-volume samples A_1 and A_2
- c. Split sample B into equal volumes and add a spike T to one of them; the latter sample becomes sample B_{SF} . As with all spikes, the addition of T should approximately double the anticipated concentration level.
- d. Add the same spike T to a distilled water sample furnished by the laboratory and designate this sample as D_F .

These QC samples must be treated in the same way as routine samples; i.e., the volume, type of container, preservation, labeling, and transportation must be the same for all.

6.5.2 Steps for the Laboratory

The laboratory personnel should perform the following steps for quality assurance:

- a. Analyze the blank and midpoint standard recommended in section 6.4. If results are unsatisfactory, resolve problems before continuing.
- b. Analyze sample D_F . If the percent recovery of T is unsatisfactory (see section 6.3.1), create a similarly spiked, distilled-water sample D_L and analyze to test for a systematic error in the laboratory or fundamental problems with the spike. If the percent recovery of T from D_L is satisfactory, any systematic error occurred before the samples reached the laboratory.
- c. Analyze samples B and B_{SF} . If B is below the detection limit, or if B is greater than $10T$ or less than $0.1T$, disregard the remainder of this step and proceed to step d. If the percent recovery of T from B_{SF} is unsatisfactory (see section 6.3.1), spike an aliquot of sample B the same way in the laboratory so that a similar recovery can be anticipated. Analyze this sample B_{SL} to test for immediate sample interferences or a bad background result B . If the percent recovery from B_{SL} is satisfactory, then the interference must require a longer delay before analysis, or other special conditions not present in the laboratory, in order to have a noticeable effect upon recovery of the spike.
- d. Analyze A_1 and A_2 . If the absolute (unsigned) difference between these results exceeds the critical value (see section 6.3.2), then precision is out of control.
- e. Calculate the absolute difference between A_1 and B . If it is unsatisfactory (see section 6.3.2), the field sampling procedure did not provide representative samples.

If initial results at each of the laboratory steps were satisfactory, then the validity of the related data has been indisputably established. If results at any step are unsatisfactory, resolution depends upon the problem identified. Laboratory problems may just require that the analyses be repeated, but field problems will usually require new samples. Figure 6-3 is intended to clarify the interdependence of the preceding laboratory steps b through e.

In figure 6-3 it must be noted that there is no way to identify *additive* sample interferences; i.e., those that have an equal effect upon the background-plus-spike results (B_{SF} or B_{SL}) and the background result B . Recovery of a spike will not show such interferences.

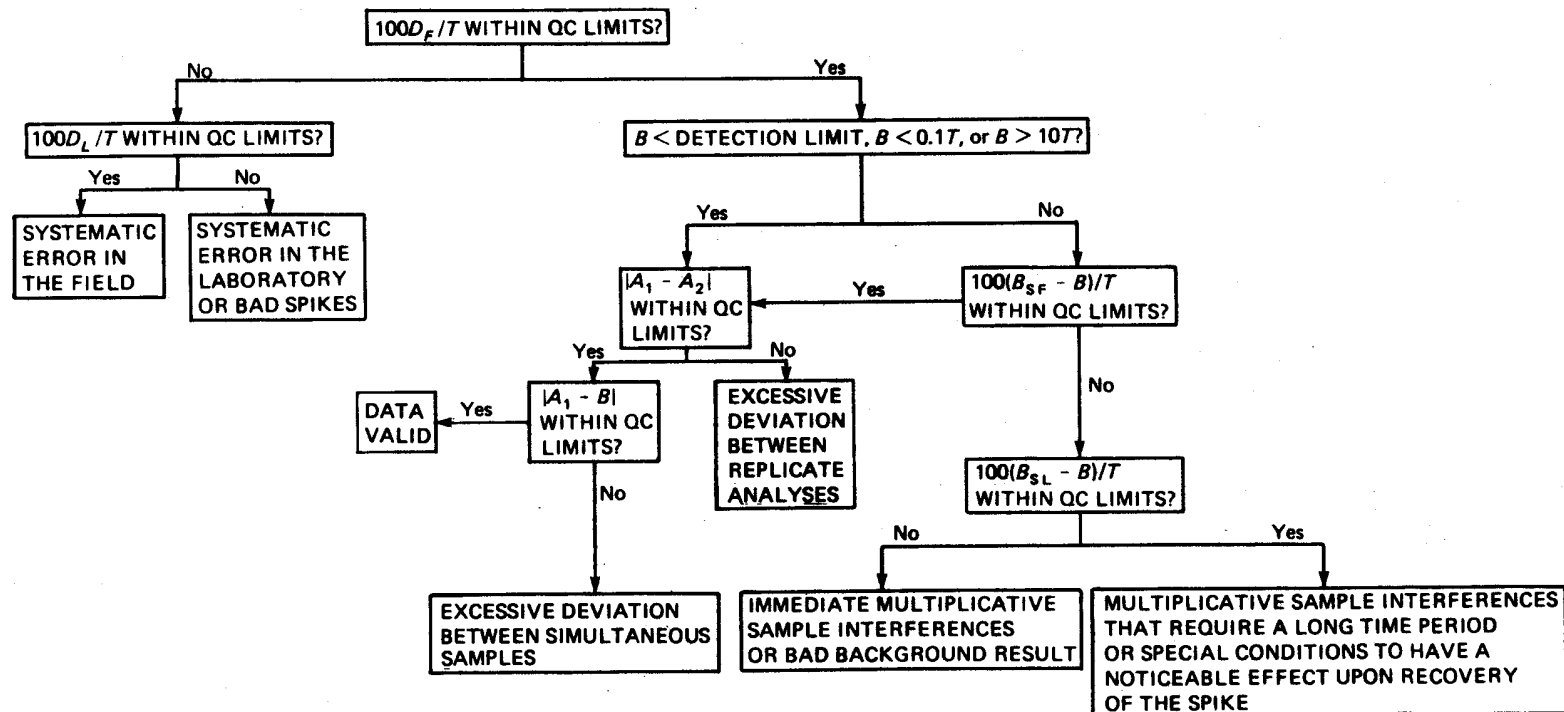

Figure 6-3. Procedure for evaluating QC data from a monitoring study.

Problems causing systematic errors that may occur in the field include the following:

- a. Contaminated preservative, distilled water, or containers
- b. Contamination by sampling personnel
- c. Deterioration through excessive holding, time or use of an ineffectual preservation technique
- d. Use of a bad field-spiking procedure

6.6 Related Topics

6.6.1 Advanced Laboratory Automation and Its Effect on QC

Advanced laboratory automation systems under development analyze samples automatically and use a control computer to interpret the resulting data and produce an analytical report. The primary benefits of such a system are not only that the data-recording and calculation errors common to manual analyses have been inherently eliminated, but also that extensive QC can be accomplished quite easily and cheaply. The computer can be programmed to automatically recognize different kinds of QC samples and to establish or recall appropriate control limits. Thus the QC overhead is reduced considerably and QC procedures previously too costly or complex become practical.

As an example of a QC procedure that is considered impractical for manual use, regression could be used to determine the relationship between concentration change and the accuracy and precision statistics discussed earlier. Using these relationships, very responsive, single accuracy and precision charts could be developed for each parameter. As computer-assisted analysis becomes common, automated laboratories will very likely replace the manual procedures recommended earlier in this chapter with evaluation criteria based upon regressions.

6.6.2 Method Comparability (Equivalency)

Requirements for method comparability are under development for proposed alternatives to the methodology specified in Public Law 92-500, section 304(g). A final version of these requirements should be available from EPA at a later date.

6.7 References

1. Shewhart, W. A., *Economic Control of Quality of Manufactured Product*, Van Nostrand Reinhold Co., Princeton, N.J. (1931).
2. Duncan, A. J., *Quality Control and Industrial Statistics*, 3d Edition, Ch. 18, R. D. Irwin, Inc., Homewood, Ill. (1965).
3. Grant, E. L., and Leavenworth, R. S., *Statistical Quality Control*, 4th Edition, McGraw-Hill Book Co., Inc., New York (1972).
4. Davies, O. L., and Goldsmith, P. L., *Statistical Methods in Research and Production*, 4th Edition, Hafner Publishing Co., New York (1972).
5. *Laboratory Quality Control Manual*, 2d Edition, U.S. EPA, Region VI, Surveillance and Analysis Division, Ada, Okla. (1972).

6. Winter, J., Britton, P., Clements, H., and Kroner, R., "Total Mercury in Water," EPA Method Study 8, pp. 35-36, U.S. EPA, Office of Research and Development, EMSL, Cincinnati (Feb. 1977).

Chapter 7

DATA HANDLING AND REPORTING

7.1 Introduction

To obtain meaningful data on water quality, the sample collector must obtain a representative sample and then deliver it unchanged for analysis. The analyst must perform the proper analysis in the prescribed fashion, complete calculations, and convert results to final form for permanent recording of the analytical data in meaningful, exact terms. These results are transferred to a storage facility for future interpretation and use.

The following sections discuss processing of actual values, recording and reporting of data in the proper way, some means of quality control of data, and the storage and retrieval of data.

7.2 The Analytical Value

7.2.1 Significant Figures

The term “significant figure” is used, sometimes rather loosely, to describe a judgment of the reportable digits in a result. When the judgment is not soundly based, meaningful digits are lost or meaningless digits are reported. On the other hand, proper use of significant figures gives an indication of the reliability of the analytical method used.

The following discussion describes the process of retention of significant figures.

A number is an expression of quantity. A figure or digit is any of the characters 0, 1, 2, 3, 4, 5, 6, 7, 8, 9, which, alone or in combination, serve to express a number. A significant figure is a digit that denotes the amount of the quantity in the particular decimal place in which it stands. Reported analytical values should contain only significant figures. A value is made up of significant figures when it contains all digits known to be true and one last digit in doubt. For example, if a value is reported as 18.8 mg/l, the 18 must be firm while the 0.8 is somewhat uncertain, but presumably better than one of the values 0.7 or 0.9 would be.

The number zero may or may not be a significant figure depending on the situation.

Final zeros after a decimal point are always meant to be significant figures. For example, to the nearest milligram, 9.8 g is reported as 9.800 g.

Zeros before a decimal point with nonzero digits preceding them are significant. With no preceding nonzero digit, a zero before the decimal point is not significant.

If there are no nonzero digits preceding a decimal point, the zeros after the decimal point but preceding other nonzero digits are not significant. These zeros only indicate the position of the decimal point.

Final zeros in a whole number may or may not be significant. In a conductivity measurement of 1,000 $\mu\text{mho}/\text{cm}$, there is no implication by convention that the conductivity is $1,000 \pm 1 \mu\text{mho}$. Rather, the zeros only indicate the magnitude of the number.

A good measure of the significance of one or more zeros interspersed in a number is to determine whether the zeros can be dropped by expressing the number in exponential form. If they can, the zeros may not be significant. For example, no zeros can be dropped when expressing a weight of 100.08 g in exponential form; therefore the zeros are significant. However, a weight of 0.0008 g can be expressed in exponential form as 8×10^{-4} g, so the zeros are not significant. Significant figures reflect the limits in accuracy of the particular method of analysis. It must be decided whether the number of significant digits obtained for resulting values is sufficient for interpretation purposes. If not, there is little that can be done within the limits of the given laboratory operations to improve these values. If more significant figures are needed, a further improvement in method or selection of another method will be required.

Once the number of significant figures obtainable from a type of analysis is established, data resulting from such analyses are reduced according to set rules for rounding off.

7.2.2 Rounding Off Numbers

Rounding off of numbers is a necessary operation in all analytical areas. It is automatically applied by the limits of measurement of every instrument and all glassware. However, when it is applied in chemical calculations incorrectly or prematurely, it can adversely affect the final results. Rounding off should be applied only as described in the following sections.

7.2.2.1 Rounding-Off Rules

If the figure following those to be retained is less than 5, the figure is dropped, and the retained figures are kept unchanged. As an example, 11.443 is rounded off to 11.44.

If the figure following those to be retained is greater than 5, the figure is dropped, and the last retained figure is raised by 1. As an example, 11.446 is rounded off to 11.45.

If the figure following those to be retained is 5, and if there are no figures other than zeros beyond the five, the figure 5 is dropped, and the last-place figure retained is increased by one if it is an odd number or it is kept unchanged if an even number. As an example, 11.435 is rounded off to 11.44, while 11.425 is rounded off to 11.42.

7.2.2.2 Rounding Off Arithmetic Operations

When a series of numbers is added, the sum should be rounded off to the same number of decimal places as the addend with the smallest number of places. However, the operation is completed with all decimal places intact, and rounding off is done afterward. As an example,

$$\begin{array}{r} 11.1 \\ 11.12 \\ +11.13 \\ \hline 33.35 \end{array}$$

The sum must be rounded off to 33.4.

When one number is subtracted from another, rounding off should be completed after the subtraction operation, to avoid possible invalidation of the operation.

When two numbers are to be multiplied, all digits are carried through the operation, then the product is rounded off to the number of significant digits of the multiplier with the fewer significant digits.

When two numbers are to be divided, the division is carried out on the two numbers using all digits. Then the quotient is rounded off to the number of significant digits of the divisor or dividend, whichever has the fewer.

When a number contains n significant digits, its root can be relied on for n digits, but its power can rarely be relied on for n digits.

7.2.2.3 Rounding Off the Results of a Series of Arithmetic Operations

The preceding rules for rounding off are reasonable for most calculations; however, when dealing with two nearly equal numbers, there is a danger of loss of all significance when applied to a series of computations that rely on a relatively small difference in two values. Examples are calculation of variance and standard deviation. The recommended procedure is to carry several extra figures through the calculations and then to round off the final answer to the proper number of significant figures.

7.3 Glossary of Statistical Terms

To clarify the meanings of statistical reports and evaluations of water quality data, the following statistical terms are introduced. They are derived in part from usage (1,2) of the American Society for Quality Control.

Accuracy – The difference between an average value and the true value when the latter is known or assumed.

Arithmetic mean – The arithmetic mean (or average) of a set of n values is the sum of the values divided by n :

$$\bar{X} = \frac{\sum_{i=1}^n X_i}{n}$$

Bias – A systematic error due to the experimental method that causes the measured values to deviate from the true value.

Confidence limit, 95 percent – The limits of the range of analytical values within which a single analysis will be included 95 percent of the time,

$$95 \text{ percent CL} = \bar{X} \pm 1.96S$$

where CL is the confidence level and S is the estimate of the standard deviation.

Constant – A nonvarying qualitative or quantitative characteristic of the population.

Geometric mean – A measure of central tendency for data from a positively skewed distribution (log normal),

$$\bar{X}_g = \sqrt[n]{(X_1)(X_2)\dots(X_n)}$$
$$\bar{X}_g = \text{antilog} \frac{\sum_{i=1}^n \log X_i}{n}$$

Interference – A biological or chemical attribute of a test sample that positively or negatively offsets the measured result from the true value. If interference that is not segregated and identified is present, it enlarges or reduces the method bias.

Median – Middle value of all data ranked in ascending order. If there are two middle values, the median is the mean of these values.

n – The number of values X_i reported for a sample.

N – The total number of values X_i of the entire population or universal set of data.

Population – The total set of units, items, or measurements under consideration.

Precision – Relative to the data from a single test procedure, the degree of mutual agreement among individual measurements made under prescribed conditions.

Precision data – Factors that relate to the variations among the test results themselves; i.e., the scatter or dispersion of a series of test results, without assumption of any prior information.

Range – The difference between the highest and lowest values reported for a sample.

Relative deviation (coefficient of variation) – The ratio of the standard deviation S of a set of numbers to their mean \bar{X} expressed as percent. It relates standard deviation (or precision) of a set of data to the size of the numbers:

$$CV = RD(\text{percent}) = 100 \frac{S}{\bar{X}}$$

Relative error – The mean error of a series of measured data values as a percentage of the true value X_i ,

$$RE(\text{percent}) = 100 \frac{|X - \bar{X}|}{X_i}$$

Sample – Groups of units or portions of material, taken from a larger collection of units or quantity of material, that provide information to be used for judging the quality of the total collection or entire material as a basis for action on them or on their production processes.

Series – A number of test results with common properties that identify them uniquely.

Skewness – A measure of the asymmetry of a frequency distribution,

$$K = \frac{(X_i - \bar{X})^3}{n \sigma^3}$$

This measure is a pure signed number. If the data are perfectly symmetrical, the skewness is zero. If K is negative, the long tail of the distribution is to the left. If K is positive, the long tail extends to the right.

Standard deviation – The square root of the variance of the universe,

$$\sigma = \sqrt{\frac{\sum_{i=1}^N X_i^2 - \left(\sum_{i=1}^N X_i\right)^2 / N}{N}}$$

Standard deviation estimate – The most widely used measure to describe the dispersion of a set of data. Normally $\bar{X} \pm S$ will include 68 percent, and $\bar{X} \pm 2S$ will include about 95 percent of the data from a study:

$$S = \sqrt{\frac{\sum_{i=1}^n X_i^2 - \left(\sum_{i=1}^n X_i\right)^2 / n}{n - 1}}$$

Standard deviation, single analyst – A measure of dispersion for data from a single analyst that is calculated here using an equation developed by Youden for his nonreplicate study design (3),

$$S_r = \sqrt{\frac{\sum_{i=1}^n (D_i - \bar{D})^2}{2(n - 1)}}$$

where D = the difference in paired values obtained from a single analyst.

Universe – The total set of items or measurements.

Variable – An experimentally determined estimate denoted X for a particular quality or trait of the population.

7.4 Report Forms

The analytical information reported should include the measured parameters; the details of the analysis such as burette readings, absorbance, wavelength, normalities of reagents, correction factors, blanks; and the reported data values.

To reduce errors in manipulation of numbers a general rule is to reduce handling and transposition of data to an absolute minimum. Ideally, a report form includes preliminary information about the sample and its analysis, and *the same* form is used for the final entering of data into a computer; however, such report forms are not yet common. Rather, a variety of methods is used to record data.

7.4.1 Loose Sheets

Reporting of data onto loose or ring-binder forms is a means of recording data that allows easy addition of new sheets, removal of older data, or collection of specific data segments. However, the easy facility for addition or removal also permits loss or misplacement of sheets, mixups in date sequence, and ultimately questionable status of the data for formal display or presentation as courtroom evidence.

7.4.2 Bound Books

The use of bound books is an improvement in data recording that tends to result in a chronological sequence of data insertion. Modification beyond a simple lined book improves its effectiveness with little additional effort. Numbering of pages encourages use of data in sequence and also aids in referencing data through a table of contents ordered according to time, type of analysis, kind of sample, and identity of analyst.

Validation can be easily accomplished by requiring the analyst to date and sign each analysis on the day completed. This validation can be strengthened further by providing space for the laboratory supervisor to witness the date and the completion of the analyses.

A further development of the bound notebook is the commercially available version designed for research-type work. These notebooks are preprinted with book and page numbers, and spaces for title of project, project number, analyst signature, witness signature, and dates. Each report sheet has a detachable duplicate sheet that allows up-to-date review by management without disruption of the notebook in the laboratory. The cost of research-type bound notebooks is about four times that of ordinary notebooks.*

Use of bound notebooks has been limited to research and development work where an analysis is part of a relatively long-term project, and where the recording in the notebook is the prime disposition of the data until an intermediate or final report is written.

However, bound notebooks can and should be used in routine analytical laboratories such as those concerned with water quality. The need for repeated information on sampling and analyses can be answered by use of preprinted pages in the bound notebooks.

7.4.3 Preprinted Report Forms

Most field laboratories and installations repetitively analyzing fixed parameters develop their own system of compiling laboratory data that may include bound notebooks, but a means of forwarding data is also required. Usually, laboratories design forms to fit a related

*Scientific Notebook Co., 719 Wisconsin Ave., Oak Park, Ill. 60304.

group of analyses or to report a single type of analysis for a series of samples. As much information as possible is preprinted to simplify use of the form. With loose-sheet, midtcopy forms (using carbon or NCR paper) information can be forwarded on the desired schedule while also allowing retention of data in the laboratory. Still, the most common means for recording data in rough form are internal bench sheets or bound books. The bench sheet or book never leaves the laboratory but serves as the source of information for transfer of data to appropriate report forms. (See fig. 7-1.)

In most instances the supervisor and analyst wish to look at the data from a sampling point or station in relation to other sampling points or stations on a particular river or lake. This review of data by the supervisor prior to release is a very important part of the QC program of the laboratory; however, such reviews are not easily accomplished with bench sheets. For review purposes, a summary sheet can be prepared that displays a related group of analyses from a number of stations such as shown in figure 7-2. Because the form contains space for all of the information necessary for reporting data, the completed form can also be used to complete the data forms forwarded to the computer storage and retrieval system.

The forms used to report data to storage systems provide spaces for identification of the sampling point, the parameter code, the type of analysis used, and the reporting terminology. Failure to provide the correct information can result in rejection of the data, or insertion of the data into incorrect parameter fields. As sample analyses are completed, the data values are usually reported in floating decimal form along with the code numbers for identifying the parameter data fields and the sampling point data fields. Figure 7-3 shows an example of a preprinted report form used for forwarding data to keypunch.

7.4.4 Plastic-Coated Labels and Forms

A recent addition to good sample handling and data management is the availability of plastic-coated (blank or preprinted) labels, report forms, and bound report books. These materials are waterproof, do not disintegrate when wet or handled, can be written on while wet, and retain pencil or waterproof ink markings though handled when wet.

7.4.5 Digital Readout

Instrumental analyses, including automated, wet-chemistry instruments such as the Technicon AutoAnalyzer, the atomic absorption spectrophotometer, the pH meter, and the selective electrode meter, provide digital readout of concentrations, which can be recorded directly onto report sheets without further calculation. Programmed calculators can be used to construct best-fit curves, to perform regression analyses, and to perform series of calculations leading to final reported values.

7.4.6 Key punch Cards and Paper Tape

Because much of the analytical data generated in laboratories is first recorded on bench sheets, then transferred to data report forms, keypunched, and manipulated on small terminal computers (or manipulated and stored in a larger data storage system), there is a danger of transfer error that increases with each data copy. The analyst can reduce this error by recording data directly from bench sheets onto punch cards that can be retained or forwarded immediately to the data storage system. Small hand-operated keypunch machines are available.

NL-C-88

(7-88)

Spectrographic Analyses Bench Data

Sample # _____ Date _____ Source _____ TDS _____ Test Count _____ Sec _____
_____ ml. conc. to _____ ml. Factor _____ 1. _____
2. _____
3. _____

	Count			Rerun Count			Av. Count	PPM In Conc. Sample	Less Than	($\mu\text{g/l}$) PPB Orig. Sample
1. Zn	_____	_____	_____	_____	_____	_____	_____	_____	<input type="checkbox"/>	<input type="checkbox"/>
2. Cd	_____	_____	_____	_____	_____	_____	_____	_____	<input type="checkbox"/>	<input type="checkbox"/>
3. As	_____	_____	_____	_____	_____	_____	_____	_____	<input type="checkbox"/>	<input type="checkbox"/>
4. B	_____	_____	_____	_____	_____	_____	_____	_____	<input type="checkbox"/>	<input type="checkbox"/>
5. P	_____	_____	_____	_____	_____	_____	_____	_____	<input type="checkbox"/>	<input type="checkbox"/>
6. Fe	_____	_____	_____	_____	_____	_____	_____	_____	<input type="checkbox"/>	<input type="checkbox"/>
7. Mo	_____	_____	_____	_____	_____	_____	_____	_____	<input type="checkbox"/>	<input type="checkbox"/>
8. Mn	_____	_____	_____	_____	_____	_____	_____	_____	<input type="checkbox"/>	<input type="checkbox"/>
9. Al	_____	_____	_____	_____	_____	_____	_____	_____	<input type="checkbox"/>	<input type="checkbox"/>
10. Be	_____	_____	_____	_____	_____	_____	_____	_____	<input type="checkbox"/>	<input type="checkbox"/>
11. Cu	_____	_____	_____	_____	_____	_____	_____	_____	<input type="checkbox"/>	<input type="checkbox"/>
12. Ag	_____	_____	_____	_____	_____	_____	_____	_____	<input type="checkbox"/>	<input type="checkbox"/>
13. Ni	_____	_____	_____	_____	_____	_____	_____	_____	<input type="checkbox"/>	<input type="checkbox"/>
14. Co	_____	_____	_____	_____	_____	_____	_____	_____	<input type="checkbox"/>	<input type="checkbox"/>
15. Pb	_____	_____	_____	_____	_____	_____	_____	_____	<input type="checkbox"/>	<input type="checkbox"/>
16. Cr	_____	_____	_____	_____	_____	_____	_____	_____	<input type="checkbox"/>	<input type="checkbox"/>
17. V	_____	_____	_____	_____	_____	_____	_____	_____	<input type="checkbox"/>	<input type="checkbox"/>
18. Ba	_____	_____	_____	_____	_____	_____	_____	_____	<input type="checkbox"/>	<input type="checkbox"/>
19. Sr	_____	_____	_____	_____	_____	_____	_____	_____	<input type="checkbox"/>	<input type="checkbox"/>

Figure 7-1. Example of bench sheet.

MINERALS ANALYSES OF ZONE B, OHIO RIVER SAMPLES, CONC., mg/l.

STATION	Storet Number	Date	Alkalinity	Hardness	Chloride	Sulfate	Fluoride	SOLIDS		
								Total	Diss.	Susp.
Ohio at Ironton	200152									
Ohio at Greenup Dam	200001									
Ohio at Portsmouth	200139									
Scioto at Lucasville	381710									
Ohio at Maysville	200153									
Ohio at Meldahl Dam	383070									
Little Miami at Cincinnati	380090									
Ohio at Cincinnati	380037									
Licking at 12th Street	200523									
Ohio at Miami Fort	383072									
Ohio at Markland Dam	200521									
Kentucky at Dam I	200522									
Ohio at Madison	174304									
Great Miami at Eldean										
Great Miami at Sellars Road	383047									
Great Miami at Liberty-Fairfield Road	383015									
Great Miami at American Materials Bridge	383007									
Whitewater at Suspension										
Great Miami at Lawrenceburg (Lost Bridge)	383071									

Figure 7-2. Example of summary data sheet.

LABORATORY BENCH DATA				COMPUTER CODED DATA							
STATION DESIGNATION		YR.	MO.	DAY	STATION CODE SERIAL		YR.	MO.	DAY		
HOUR & MINUTE OF SAMPLE OR LAST DATE OF COMPOSITE SAMPLE				1-6		7-12		13-18			
ITEM <u>Fecal Streptococci</u> UNIT <u>MF/100</u>				PARAMETER CODE		VALUE		EXPONENT		RMKS	
1	1	1	1	1	1	1	1	1	1	1	
8	7	6	5	4	3	2	1	0	1	2	
ITEM <u>Fecal Coliform</u> UNIT <u>MF/100</u>				19-23		24-27		28		29	30
1	1	1	1	1	1	1	0	0	0	0	
8	7	6	5	4	3	2	1	0	1	2	
ITEM <u>NH₃-N + Org N</u> UNIT <u>mg/l</u>				31-35		36-39		40		41	42
1	1	1	1	1	1	1	0	0	0	0	
8	7	6	5	4	3	2	1	0	1	2	
ITEM <u>NH₃-N</u> UNIT <u>mg/l</u>				43-47		48-51		52		53	54
1	1	1	1	1	1	1	0	0	0	0	
8	7	6	5	4	3	2	1	0	1	2	
ITEM <u>NO₂-N + NO₃-N</u> UNIT <u>mg/l</u>				55-59		60-63		64		65	66
1	1	1	1	1	1	1	0	0	0	0	
8	7	6	5	4	3	2	1	0	1	2	
ITEM <u>P, Total</u> UNIT <u>mg/l</u>				67-71		72-75		76		77	78
1	1	1	1	1	1	1	0	0	0	0	
8	7	6	5	4	3	2	1	0	1	2	
ITEM <u>P, Soluble</u> UNIT <u>mg/l</u>				79		80		81		82	83
1	1	1	1	1	1	1	0	0	0	0	
8	7	6	5	4	3	2	1	0	1	2	
ITEM <u>TOC</u> UNIT <u>mg/l</u>				84		85		86		87	88
1	1	1	1	1	1	1	0	0	0	0	
8	7	6	5	4	3	2	1	0	1	2	
ITEM <u>Phenol</u> UNIT <u>µg/l</u>				89		90		91		92	93
1	1	1	1	1	1	1	0	0	0	0	
8	7	6	5	4	3	2	1	0	1	2	
ITEM <u>Cyanide</u> UNIT <u>mg/l</u>				94		95		96		97	98
1	1	1	1	1	1	1	0	0	0	0	
8	7	6	5	4	3	2	1	0	1	2	

Figure 7-3. Example of STORET report form.

7.4.7 STORET-Computerized Storage and Retrieval of Water Quality Data

Because of their ability to record, store, retrieve, and manipulate huge amounts of data, the use of computers is a natural outgrowth of demands for meaningful interpretation of the great masses of data generated in almost all technical activities.

In August 1961, numerous ideas were brought together concerning the basic design of a system called STORET for storage and retrieval of water pollution control data. A

refinement of this system is now operated by the Technical Data and Information Branch, Division of Applied Technology, Office of Water Programs, EPA.

This is a State/Federal cooperative activity that provides State water pollution control agencies with direct, rapid access into a central computer system for the storage, retrieval, and analysis of water quality-control information.

If properly stored, the data can be retrieved according to such descriptors as the point of sampling, the date, and the specific parameters stored, or all data at a sample point or series of points can be extracted as a unit.

Full details on use of the STORET system are given in the recently revised STORET handbook (4).

7.4.8 Automated Laboratory Systems

The use of digital readout, keypunch cards, and paper tape have been overshadowed by the development of customized, fully automated online computer systems that make measurements, calculate results, perform quality control, and report analytical data simultaneously from a full range of laboratory instruments. (See fig. 7-4.) Such systems can contain the following functions:

- a. Manual or automatic sampling and testing of a series of samples, standards, replicates, and check samples
- b. Detection of the measurement signals from the series of samples
- c. Conversion of signals to concentrations, generation of a standard curve, and calculation of sample values in final units
- d. Calculation of the deviation and recovery values of the results and indication of acceptance or nonacceptance based on limits established by the analyst
- e. Provision of the output in a form designated by the analyst: dial, paper recording chart, digital readout, cathode ray tube, or printed report form

The degree of hands-on operation required in the system is specified by the analyst.

If an automated system is properly designed and operated, most calculation and transposition errors are avoided and the proper level of quality control is automatically exerted. Laboratory automation systems for water analyses are being developed and coordinated by EMSL-Cincinnati for use in a number of EPA laboratories (5).

7.5 References

1. "Guide for Measure of Precision and Accuracy," *Anal. Chem.* 33, 480 (1961).
2. "Glossary of General Terms Used in Quality Control," *Quality Progress*, Standard Group of the Standards Committee, American Society for Quality Control, *II*(7), 21-2 (1969).
3. Youden, W. J., *Statistical Techniques for Collaborative Tests*, Association of Official Analytical Chemists, Washington, D.C. (1967).

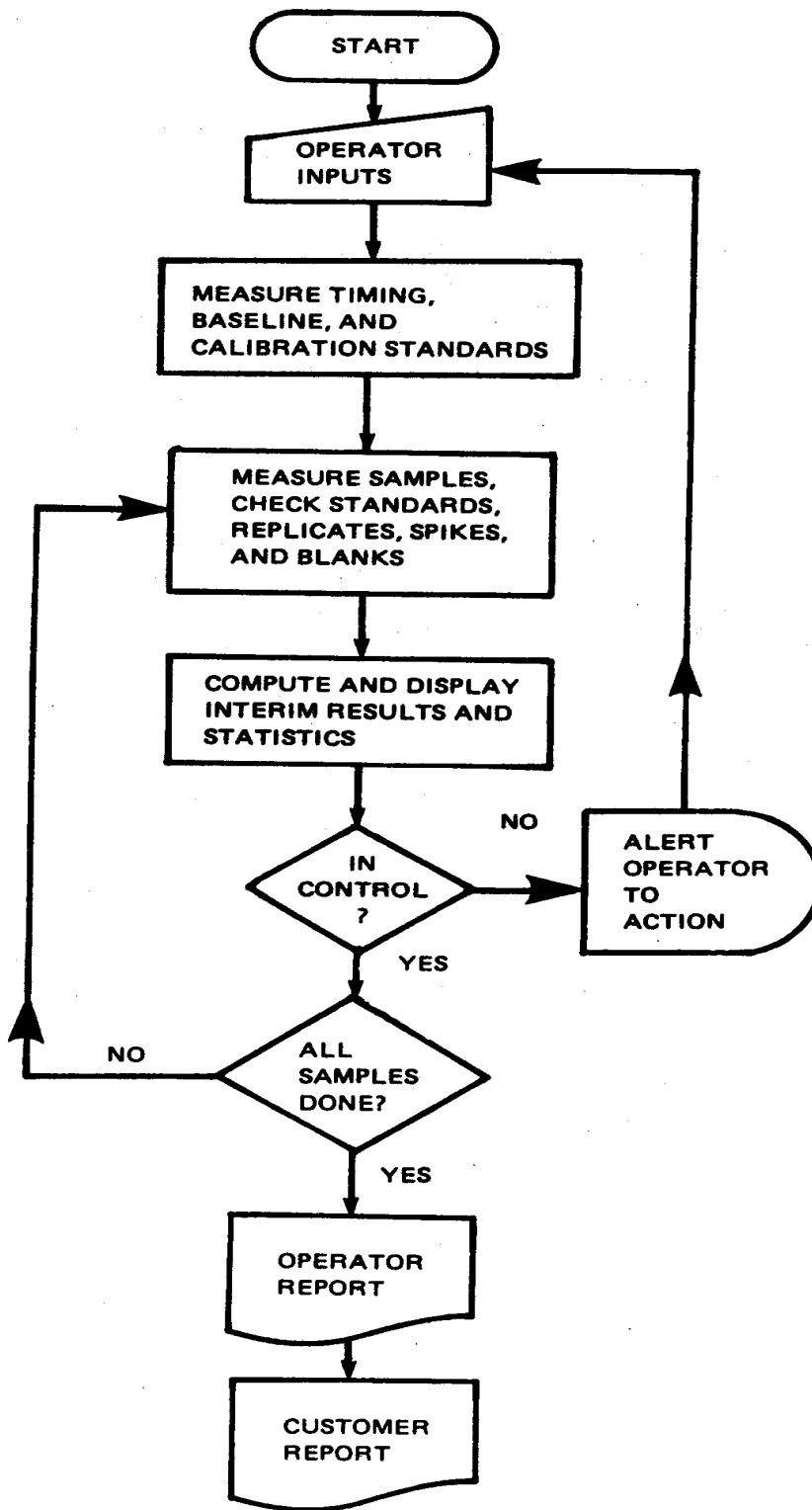

Figure 7-4. Flow chart of the sequence of events during a controlled series of laboratory measurements.

4. "STORET, EPA's Computerized Water Quality Data Base, the Right Answer," U.S. EPA, Office of Water and Hazardous Materials, Washington, D.C. (1977).
5. Budde, W. L., Almich, B. P., and Teuschler, J. M., The Status of the EPA Laboratory Automation Project, EPA-600/4-77-025, U.S. EPA, Office of Research and Development, EMSL, Cincinnati (1977).

SPECIAL REQUIREMENTS FOR TRACE ORGANIC ANALYSIS

8.1 Introduction

The high sensitivity of the instrumentation used in trace organic chemical analysis and the low concentration of organic compounds being investigated dictate that special attention must be given to this analytical field. Contamination of the sample from any possible source must be diligently guarded against, and interferences in the sample must be carefully controlled. Strict attention to method and highly refined technique are required to produce valid quantitative and qualitative results.

Two manuals have been developed by the Environmental Monitoring and Support Laboratory (EMSL) in Cincinnati covering the two broad areas of quantitative and qualitative trace organic analysis. Reference 1 contains both general and specific quality assurance programs designed to insure the production of acceptable measurements when using the methods contained in that manual. Reference 2 contains specific, detailed quality assurance programs covering both the performance of the instrument and the interpretation of the resulting spectra.

This chapter is organized with three sections devoted to general material applicable to all organic analysis, and one section abstracting highly specialized materials from each of the two manuals cited.

8.2 Sampling and Sample Handling

Regardless of the intent, all numbers generated by a water quality laboratory are ultimately represented as the concentration levels in the sample matrix at the time of collection. Such numbers tend, automatically, to endorse the sample collection, preservation, and shipment procedures. Thus, quality assurance programs limited to the care of the sample beginning with its receipt by the laboratory are inadequate. The laboratory must share responsibility for the preservation and shipment of all samples that it will accredit with concentration values. Two approaches are available that will generally protect the laboratory from generating numbers that may not reflect actual conditions of the sample at the time of collection. The best, but usually least practical solution, is for the laboratory personnel to collect all samples. The alternative is for the laboratory to adopt a policy of sample rejection based on minimum standards of sample identification and age. Guidelines for establishing these standards are discussed in this section. It is recommended that copies of this material be supplied to all sample collectors along with an understanding of the specific policy of the laboratory toward rejecting samples that do not meet these criteria.

In all of the cases to be discussed, it is the responsibility of the project director to (a) coordinate his sampling, preservation, and shipment with the laboratory, (b) obtain clean sample containers from the laboratory, (c) provide adequate sample identification and compositing instructions, and (d) provide duplicates and blanks as required by the laboratory. Additional prearrangements should be made with the laboratory if sample splitting is desired, to create separate supernatant and settleable matter samples, or if calculations on a wet-weight basis in addition to the standard dry-weight calculations are desired.

Bottles and caps are to be supplied by the laboratory because rigorous cleaning is required even for new bottles. New and recycled bottles should be washed as described in reference 1. Samples received in bottles of unknown origin or questionable cleanliness should be rejected by the laboratory. For water samples that are to be analyzed by solvent extraction methods, narrow-mouthed, screw-cap bottles such as Boston rounds are preferred because they have less tendency to leak and are easy to handle in the laboratory. One-liter bottles are generally more expensive than quart bottles, thus most laboratories use the clear 32-oz containers. The bottle should be sealed with Teflon (du Pont) lined caps. For water samples of intermediate pH, aluminum-foil-lined caps may be used when Teflon (du Pont) is not available. Oil and grease samples can be collected with Polyseal caps – the conical liner provides an excellent seal against pressure during shipment and sample extraction. Screw-cap, widemouthed glass bottles are preferred for sediment samples because they are easier to handle in the field and in the laboratory. Precleaned, 16- or 32-oz bottles with Teflon (du Pont) or foil-lined screw-cap closures should be provided by the laboratory. Masking tape or other suitable labels should be applied to the dry bottles.

Sampling for purgeable organics requires special consideration and equipment. The sample container should consist of a 45-ml, screw-cap vial fitted with a Teflon (du Pont) faced, silicone septum.* The vials, septa, and caps should be washed in hot detergent water and thoroughly rinsed with tapwater and organic-free water, then dried at 105°C for 1 h. The vials should then be cooled to room temperature in a contaminant-free area. When cool, the vials should be sealed with the septa, Teflon (du Pont) side down, and screw cap and maintained in this sealed condition until filled with sample.

The bottles used for collecting water samples for solvent extraction should not be overfilled or prerinsed with sample before filling because oil and other material that can cause erroneously high results may remain in the sample bottle after rinsing. Bottles should be filled with sample to about 90 percent of capacity, and the level should be marked to determine if leakage occurs. Because full sample bottles are difficult to pour from during extractions, complete filling should be avoided. In the collection of sediment samples, nonrepresentative debris such as large stones or wood should be discarded.

Multiple samples are usually required for purgeable organics analysis because of leakage and because the measurement process is destructive to the sample. All vials should be identified with waterproof labels. The water sample vials are filled to overflowing from a bubble-free source so that a convex meniscus is formed at the top. They are sealed by carefully placing the septum, Teflon (du Pont) side down on the opening of the vial and screwing the cap firmly in place.

Shipment and receipt of samples must be coordinated with the laboratory to minimize time in transit because it is the prerogative of the laboratory to reject samples where delays in shipment have caused them to age beyond acceptable holding times. To avoid the need to resample, the sampler should determine in advance the most efficient and reliable form of transportation for the samples. All samples for organic analysis should arrive at the laboratory on the same day collected, or should be shipped and maintained at less than 4°C for arrival by the next day. The samples are usually shipped in insulated ice chests. Water samples should be prechilled before packing to reduce the ice requirements during shipment.

*Vial and septum are available from Pierce Chemical Co., P.O. Box 117, Rockford, Ill. 61105. Vial: No. 13074; septum: No. 12722.

The bottles should be stabilized in the container with styrofoam and covered with ice. The information needed to identify the samples should be attached to the outside of the ice chest.

A part of the quality assurance program for a laboratory must be the development of a clear policy for accepting or rejecting samples. Because organic analyses are expensive in terms of manpower and supplies, it is poor management to commit such resources just to obtain data of questionable validity. Water samples that clearly have not met the preservation criteria during shipment (e.g., in the case of a spill) should be accepted only if resampling is impossible. Results from such samples must be qualified in the laboratory report.

Upon receipt, the samples should be checked for adequate identification, sample temperature or presence of ice in the chest, and leakage. Samples for volatile organics should be checked for air bubbles, although it is extremely difficult to avoid the development of very small bubbles regardless of the type of sample bottle employed. The samples are logged in with the receipt time noted. Unless the condition of the samples fails to meet the criteria for acceptance by the laboratory, required preservatives are added immediately and the samples are all refrigerated.

The laboratory staff should be alerted to the arrival of the samples, so that the required analysis can begin as soon as possible. When sediment samples are to be reported on a wet-weight basis, or when a water sample is to be filtered or divided into supernatant and settleable subsamples for separate analysis, the sample processing should begin promptly.

When analysis of water samples is to be restricted to the water phase only, filtration is required. This may be accomplished with 4.7-cm, glass-fiber filter disks that have been preextracted with acetone and allowed to dry. The filter disks must not contain organic binder. The disks are placed on a membrane filter holder and up to a liter of water is filtered. The filtrate is transferred without rinsing to a clean sample container and treated as a normal, whole-water sample.

When separate reporting is required for the settleable and supernatant phases, the water sample (or a large portion of it) is allowed to settle overnight in a closed glass container at 4°C. If phase separation occurs, the supernatant phase is carefully decanted or siphoned into a graduated cylinder without disturbing the surface of the settled material. After the volume of supernatant is noted, the supernatant is filtered as just described into a clean glass container and stored at 4°C. The volume of settled material is determined either by marking the slurry level on the side of the sample container for later calibration, or by transferring the slurry without washing into a calibrated vessel. A portion of well-mixed slurry is removed for a determination of percent solids. The remaining slurry is stored in a sealed glass container at 4°C.

When both dry-weight and wet-weight results are required for sediments and sludges, a percent-solids determination should be performed soon after receipt of the sample. A representative portion (ideally 10 to 25 g) of well-mixed sample is weighed into a tared Erlenmeyer flask and dried at 105°C to a constant weight. Then percent solids are calculated for the sample.

Routine laboratory management involves detailed recordkeeping beginning with the initial contact with the sample collector. A master flowsheet should be prepared for each sample, listing parameters to be determined and pretreatment operations to be performed. The

master flowsheet is kept at a fixed location and is designed to handle dated entries indicating when operations are completed. Methods requiring extraction permit double entry on the master flowsheet so laboratory throughput times can be calculated in terms of receipt-to-extraction and receipt-to-completion times. A separate set of forms follows the sample through the laboratory. Each sample form records information for a class of parameters and details cleanup operations and other method options. Calculations and cross references to chromatograph files are entered on the sample form also.

A chain-of-custody program lends significant legal support to the results generated. The program begins when the laboratory dispatches the sample collectors. Each time a sample is collected, a form is initiated stating where and when the sample was collected, with cross reference to a number on the sample container. The sample collectors return to the laboratory with the samples in their guarded possession and deliver them personally to the responsible person in the laboratory. The person (custodian) receiving the samples in turn signs each ledger to acknowledge receipt and locks the sample in a refrigerator. The analyst then comes to the custodian and signs for the sample that he is taking for analysis. In this way full documentation of the sample handling is maintained from sample collection through completion of the analysis.

8.3 Extract Handling

Each method in reference 1 is prepared in sections identified by titles. This style of presentation is aimed at presenting the analyst logical places to interrupt his analysis. Often, because of the length of the method, the analyst is unable to complete an analysis in a single day. When planning a partial analysis, certain factors must be considered. Because the organics are generally more stable in solvent than in water, it is always preferable to extract a sample and hold the extract rather than to hold the sample. Extracts to be held overnight or longer should first be dried by treatment with sodium sulfate.

The methods include several transfers of the solvent extract from one piece of glassware to another. These quantitative transfers are made using several small portions of solvent to wash the walls of the previous container. A 5-ml, luer-lock glass syringe with a 2-in., 20-gage needle is convenient for this purpose. Solvents tend to creep up the outside of a container, such as an ampoule, while pouring. To minimize contamination during transfer, solvent extracts are poured as rapidly as possible. Extracts can become contaminated not only from oils from the skin of the handler but also from other extracts handled at the same time where deposits on the outside of the container are unintentionally transferred from one container to another. Instead of using labels, contamination problems from this source can be reduced by etching permanent numbers on ampoules. Sample log sheets should be used to index the extract with a numbered ampoule, eliminating the need for tape or wax pencils.

Of the several ways to dry a solvent extract with sodium sulfate, passing it through a chromatographic column packed with 2 to 3 in. of anhydrous crystals is the most convenient and quantitative. When a wet extract is being transferred from a separatory funnel to a Kuderna-Danish (K-D) concentrator, it should be drained directly through the column to eliminate the need for an intermediate piece of glassware and the resulting transfer step. Prewashing the sodium sulfate column with extracting solvent is recommended, although interferences can be controlled by preheating the salt in a shallow tray at 400°C for 30 min. After the extract has passed through the column, 20 to 30 ml of extracting solvent are used to wash the residual extract from the column.

The standard K-D concentration apparatus consists of a three-ball Snyder column, a 500-ml flask, and a calibrated ampoule. It is designed to concentrate 100- to 300-ml volumes of extract to a final volume of 5 to 10 ml. To use the apparatus, one 10/20 mesh boiling chip (previously rinsed with solvent and heated for 1/2 h) is added, and the assembly is supported above a concentric-ring water bath with the tip of the ampoule below the surface of the water. The lower ground-glass joint must be kept above the water. The water temperature should be adjusted for mflld distillation, with no chamber flooding or splashing (about 10°C to 20°C above the boiling point of the solvent). When the volume of liquid reaches 1 to 2 ml (checked frequently), the assembly should be removed and allowed to cool. The chambers and flask will drain to a final volume near 10 ml. The flask and the lower ground-glass joint are rinsed with a minimum of solvent. The evaporation can be continued with the microscale K-D concentrator if further concentration is required.

The microscale K-D concentrator is designed to concentrate extracts from 5 to 10 ml to 1.0 ml. A fresh boiling chip must be added, and a two-ball micro-Snyder column is attached to the ampoule. The ampoule is supported above the water bath, and the extract is concentrated to about 0.7 ml. The column and ground-glass joint are rinsed with a minimum of solvent, and the volume is adjusted to 1.0 ml.

The K-D concentrator can be used to exchange solvents. When the sample is dissolved in a solvent unsuitable for a cleanup operation or for gas chromatography (GC), it can be displaced by a suitable higher boiling solvent. The actual volumes that should be used to effect the exchange vary with the solvent pairs depending upon the difference in boiling points and azeotrope formations, but a general procedure is to concentrate the extract to 10 ml, add 20 ml of the higher boiling solvent, and reconcentrate to 10 ml.

After extractions and subsequent K-D concentrations, solubilities of some materials may be exceeded. High sulfur levels are a particular problem encountered in sediment extractions. Extracts should be decanted from ampoules where sulfur has crystallized. In some samples the extractable organic levels are so high the extract tends to solidify and will not concentrate further. When this occurs, a small aliquot of the extract should be taken and diluted as appropriate for final analysis.

A significant source of the variation in GC analysis can be attributed to the injection of a portion of the extract into the analytical system. Manual injections of 2 to 3 μ l with the use of a 10- μ l syringe will introduce variance even when the injection volumes are determined to the nearest 0.05 μ l. Of a variety of injection techniques in use, the solvent flush technique has been found to be acceptable for quantitative work. This technique is described in detail in reference 1.

8.4 Supplies and Reagents

Reference compounds of materials should be assayed and of 98 percent purity or higher. If the purity is less than 98 percent, the appropriate correction factor must be included in all calculations of standard concentration. The reference materials should be cataloged, dated, and stored in a refrigerator.

Stock solutions of these reference materials should be prepared in a high-boiling, inert solvent, if possible, to minimize errors due to evaporation or solvent-induced decomposi-

tion. The laboratory should have an accurate six-place balance for preparing small quantities of reference standards. The following method of preparing stock solutions is recommended: Weigh 10 mg (to the nearest 0.01 mg) of reference standard into a small aluminum weighing pan.* Drop the entire pan into a 10-ml volumetric flask. Dissolve the reference material in about 5 ml of solvent, then dilute to volume. Label the solution with compound name, concentration, solvent used, date prepared, and initials of preparers. Store the volumetric in a refrigerator, except when preparing dilutions. When the standard is a replacement for an existing stock solution, the two solutions should be compared, and the results as well as the suspected reason for any variation should be permanently recorded in the laboratory files.

Working standards are prepared from one or more stock solutions after they have warmed to room temperature. As these working standards usually represent three to six orders of magnitude of dilution of the stock standards, it is obviously necessary to take great care in preparing them. Serial dilutions are recommended with a maximum of 1:100 dilution for each step. Although 10- μ l volumes can be read within 1 percent with a 10- μ l syringe, the inherent problems with the dead volume in the syringe make the use of such equipment less desirable for preparing working standards than volumetric pipets. New working standards should be prepared frequently unless long-term stability has been demonstrated. When several compounds are combined into a single standard for simultaneous GC, they must be closely monitored for chemical interactions.

Pesticide-quality solvents are usually required, and each new lot should be checked for interferences prior to use. The solvent check, representing approximately 10 percent more solvent than required for any method, should be concentrated and analyzed for method interferences under all GC conditions applicable to that solvent. If interfering peaks or a broad solvent front are observed, the solvent should be redistilled in an all-glass distillation system, with a distillation column.** If interferences persist, the solvent lot should be discarded. This preliminary lot check does not eliminate the need for routine solvent blanks to monitor for purity changes over a period of time.

Diethyl ether must be shown to be free of peroxides before use. Peroxide test strips† can be used for a quick, convenient test. The alumina column procedure for removing peroxides, described in literature supplied with the test strips, has been used successfully to remove all peroxides from the solvent. The solvent should always be stabilized with 2 percent volume/volume ethyl alcohol. Chromatographic elution patterns are based on ether containing this alcohol.

Granular sodium sulfate should be purchased in glass containers. If purchased in a large container (5-lb bottles or larger), it should be transferred to smaller bottles for daily use. Before sodium sulfate is used for chromatographic work, it should be heated to 400°C for 30 min and shown not to be contaminated. When the sodium sulfate is used to dry extracts before concentration, the heating is usually unnecessary because impurities will be removed by preelution of the drying column with solvent.

* Available from The Perkin-Elmer Corp., Norwalk, Conn.; No. 219-0041.

** Available from Lab Glass, Inc., North West Blvd., Vineland, N.J. 08360; Widner No. LG-5930.

† Available from Scientific Products, 1430 Waukegan Rd., McGaw Park, 111. 60085; Quant peroxide test strip, No. PI 126-8.

Florisil (Floridin Co.) is purchased from the manufacturer preactivated at 630°C and transferred to glass containers with Teflon (du Pont) or foil-lined lids. Prior to use the Florisil (Floridin Co.) is heated in a shallow open dish for 5 h in a 130°C oven. The Florisil (Floridin Co.) can then be transferred into a sealed, glass bottle and stored indefinitely at 130°C until needed. Cleanup methods using Florisil (Floridin Co.) require that a lauric acid value be determined for each lot before use. In addition, the determination of a pesticide elution pattern is recommended. These procedures are described in detail in reference 1.

Carrier gases are a very important part of the chromatographic system; therefore, special care should be taken in their selection and handling. Only high-purity or equivalent carrier gases should be purchased, and they should be filtered, online, through a 5-Å molecular sieve. Porous polymer and other column packings degrade at elevated temperatures in the presence of trace quantities of oxygen. Oxygen in the carrier gas also adversely affects the performance of electron-capture detectors. Therefore, some type of online oxygen-removal system is recommended for these applications. The chemical traps should be changed or regenerated with each new cylinder of carrier gas. One purifier* has been found to last through many cylinders without replacement. A better grade of gas is required for temperature programming than for isothermal operation. Combustion gases may be of lower quality but should be at least equivalent to dry air or purified hydrogen. Regulators should have stainless steel internal parts and be of two-stage design. External tubing should be of good quality, such as refrigeration tubing. Such tubing should be rinsed with solvent and heated at 200°C under gas flow before use in the analytical system.

The purchase of precoated GC column packings is strongly recommended over the preparation of coated materials in the laboratory. The commercial products are, generally, of higher quality and consistency than those prepared by the average analyst. All tubing should be cleaned before packing by passing a series of solvents (e.g., hexane, chloroform, and acetone) through it. Glass columns should also be silylated. (Instructions are included with the purchase of silylating agents.) Dry the tubing thoroughly before packing it.

A vibrator should never be used to settle the packing material in the column. Such vibration may fracture the solid support material, expose uncoated active sites, and produce inferior chromatographic separations. When vacuum alone is inadequate and further settling is required, the column may be tapped with a pencil or similar object while the vacuum is being applied. Unless otherwise stated, stainless-steel tubing should be packed before coiling it to fit the GC apparatus.

8.5 Quality Assurance

8.5.1 Measurements

Most of the quality assurance programs suggested in chapter 6 of this manual cannot easily be adapted to the methods for organic compounds. The reasons for this, and the suggested approach for a suitable program for the organic analytical laboratory are discussed in detail in reference 1 and only summarized here.

Reference 1 suggests that quality assurance for organic analysis be divided into three separate categories. The first category represents the determination of purgeable com-

* Available from Matheson Gas Products, P.O. Box E, Lyndhurst, N.J. 07071; Hydrox Purifier model No. 8301.

pounds. This determination is performed in a closed analytical system; the complete analysis can be performed in 1 h; and the number of theoretically possible interferences is somewhat limited. The second category represents liquid/liquid partition methods in a regulatory situation. Here a very limited number of compounds are being measured; there is a high occurrence of positive results; and it is important to establish that the method works satisfactorily on the particular sample matrix. The third category represents liquid/liquid partition methods in a monitoring situation. Here a large number of compounds are often being measured simultaneously; there is a low occurrence of positive results; and each sample matrix may be different. Quality assurance is aimed at establishing that the laboratory is using the method correctly.

The purgeable methods are unique among organic methods because the standards are treated in exactly the same way as the samples, and there is no inherent method bias. The methods are amenable to a variety of quality assurance programs. The approach that has been found applicable to all types of samples and provides the maximum data for the expended effort consists of the addition of one or more internal standards to the matrix before purging. Data generated in this program provide a continuous monitoring of the equipment and establishes matrix applicability for the test.

For liquid/liquid extraction methods in a regulatory situation, the emphasis is placed on duplicates and dosed samples. Both field duplicates and laboratory duplicates are used in the program to establish sampling and subsampling validity. The dosing of samples to establish method accuracy for the matrix is an integral part of this program. Where the analytical program will extend over a long period of time the construction of control charts is recommended.

When the liquid/liquid extraction methods are used for monitoring, the emphasis is placed on an external control series. A standard laboratory matrix is developed. With each series of samples the matrix is dosed and analyzed with the samples. Data generated over a period of time can be used to monitor the performance of the equipment and the analyst, with relatively tight specifications to define problems that arise. Control charts can be constructed to alert the analyst to problems, but there is no provision for rejection of results for samples of this type.

8.5.2 Identifications

The combined gas chromatography/mass spectrometer (GC/MS) has emerged as the most important single instrument at the disposal of the environmental analytical chemist. It alone can provide both the sensitivity and the high degree of certainty necessary for an identification culled from a complex environmental matrix. The instrument has generated an aura of well-deserved respect, and its results are seldom questioned. For these reasons it is mandatory that strict quality assurance programs be followed in both the generation and the interpretation of mass spectra. The EMSL, with the cooperation of many other EPA GC/MS users, has produced a procedural manual (2) generally for use with a Finnigan quadrupole instrument. A detailed quality assurance program constitutes an integral part of the manual. The actual detailed program is beyond the scope of this manual but has been summarized in the following paragraphs.

To insure that a quadrupole mass spectrometer generates quality spectra, the program provides for at least daily performance evaluation with a reference compound, and

readjustment of the instrument as necessary. The operator prepares a solution of decafluoro-triphenylphosphine (DFTPP).* When this compound is injected into the GC/MS using any of several compatible GC columns, the resulting elaborate spectrum can be evaluated using criteria developed at EMSL-Cincinnati (3).

Decafluorotriphenylphosphine key ions and the ion-abundance criteria that are used for determining whether the mass spectrometer is generating high-quality spectra are as follows:

<i>Mass (amu)</i>	<i>Abundance Criteria Ion Abundance Criteria</i>
51	30 to 60 percent of mass 198
68	Less than 2 percent of mass 69
70	Less than 2 percent of mass 69
127	40 to 60 percent of mass 198
197	Less than 1 percent of mass 198
198	Base peak, 100 percent relative abundance
199	5 to 9 percent of mass 198
275	10 to 30 percent of mass 198
365	1 percent (or greater) of mass 198
441	Less than mass 443
442	Greater than 40 percent of mass 198
443	17 to 23 percent of mass 442

If these specifications are not met, the guidelines provided for adjusting the instrument (2,3) must be considered.

Having produced quality spectra, the analyst must always ascertain, by analyzing a method blank under exactly the same analytical and instrumental conditions, that the spectra are relevant. Most commercial systems have a software program, extracted ion current profile (EICP), that permits the sample and the blank to be overlaid on a graphic display device when each is scanned for a particular mass. When large numbers of spectra result from a sample and the blank must be checked for a match for each one, this technique simplifies the screening process.

If the spectra are found to be unique to the sample, it is normally processed through a mass-spectral search-and-match system. The computerized version of such a system consists

* Available from PCR Research Chemicals, Inc., P.O. Box 1778, Gainesville, Fla. 32602; No. 11 898-4.

of an organized collection of many thousands of compound spectra stored in a large central computer accessed by the analyst through telephone linkups. On the basis of 8 or 10 major masses the computer can rapidly search the complete system for similar spectra. These spectra are ranked for similarity to the unknown using a mathematical algorithm. The resulting similarity index (SI), which can be further refined to a quality index (2), is a measure of the degree of confidence the analyst may place in the identification. If a match is not found, the analyst must revert to manual interpretation of the spectra and deduce the structure of the compound by its fragmentation patterns.

After a tentative identification is made, several other types of supporting experiments become possible. Retention-time GC/MS data of a pure compound (standard) may be compared with analogous data from the sample component. Similarly, the mass spectrum of the standard, obtained under the same conditions that were used for the sample, may be compared with the sample component spectrum. The standard may be dissolved in water at an appropriate concentration, isolated, and measured. The recovery of this spike in the same fraction in which the suspected component appeared and the observation of equivalent mass spectra for the spike and the sample component constitute strong evidence for confirmation of the identification.

8.6 References

1. Methods for Organic Analysis of Water and Wastes, U.S. EPA, EMSL, Environmental Research Center, Cincinnati (in preparation).
2. EPA GC/MS Procedural Manual, Budde, W. L., and Eichelberger, J. W., editors, 1st Edition, Vol. 1, U.S. EPA, Office of Research and Development, EMSL, Cincinnati (in press).
3. Eichelberger, J. W., Harris, L. E., and Budde, W. L., *Anal. Chem.*, *47*, 995 (1975).

Chapter 9

SKILLS AND TRAINING

9.1 General

Analytical operations in the laboratory can be graded according to the degree of complexity. Some analyses require no sample treatment, and the measurement can be performed in minutes on a simple instrument. Other determinations require extensive sample preparation prior to complex instrumental examination. Consequently, work assignments in the laboratory should be clearly defined. Each analyst should be completely trained and should fully understand all the assignments of his job before being given new responsibilities. In this regard, all analysts, subprofessional or professional, should be thoroughly instructed in basic laboratory operations, according to the degree of professional maturity. Some of the basic operations that should be reviewed periodically with laboratory personnel follow.

9.1.1 Sample Logging

Routine procedure for recording of samples entering the laboratory and assigning primary responsibility should be emphasized. The information that is required and the routing of the sample to the analyst is then established. The stability, preservation, and storage of samples prior to analyses are then discussed.

9.1.2 Sample Handling

The analyst should understand thoroughly at which points in his procedures the sample is to be settled, agitated, pipetted, etc., before he removes it from the original container.

9.1.3 Measuring

The analysts, especially new employees and subprofessionals, should be instructed in the use of volumetric glassware. The correct use of pipettes and graduates should be emphasized as discussed in chapter 4 of this manual.

9.1.4 Weighing

Because almost every measuring operation in the analytical laboratory is ultimately related to a weighing operation, the proper use of the analytical balance should be strongly emphasized. Maintenance of the balance, including periodic standardization, should be repeatedly emphasized to all personnel. The correct use and maintenance of balances is discussed in chapter 3 of this manual.

9.1.5 Glassware

All glassware should be washed and rinsed according to the requirements of the analysis to be performed. Not only must the personnel assigned to these tasks be instructed, but also all lab personnel should know the routine for washing and special requirements for particular uses of glassware. In addition, the precision tools of the laboratory such as pipets, burets,

graduates, and Nessler tubes should be inspected before use for cleanliness, broken delivery tips, and clarity of marking. Defective glassware should be discarded or segregated.

9.1.6 Instrumentation

Operation and maintenance of analytical instrumentation is of primary consideration in the production of valid data. All instruments must be properly calibrated, quality-control checks documented, and standard curves verified on a routine basis. Details on instrumental quality control are presented in chapter 3 of this manual.

9.1.7 Data Handling and Reporting

As with sample logging, the routine procedure for recording results of analyses and pertinent observations, including quality control checks, should be emphasized. Analytical data should be permanently recorded in meaningful, exact terms and reported in a form that permits future interpretation and unlimited use. Details are discussed in chapter 7 of this manual.

9.1.8 Quality Control

The need to continuously assess precision and recovery values of methodology is a prime responsibility of the analyst. Self-evaluation through the analyses of replicates and recovery of spikes from samples representative of the daily workload provides confidence and documentation of the quality of the reported data.

9.1.9 Safety

Laboratory safety should be discussed on a continuing basis with all employees, but it should be emphasized when an employee is assigned to perform new duties.

9.1.10 Improvement

In summary, quality control begins with basic laboratory techniques. Individual operator error and laboratory error can be minimized if approved techniques are consistently practiced. To insure the continued use of good technique, laboratory supervisors should periodically review the basic techniques and point out areas of needed improvement with each analyst.

Continuing improvement of technical competence by all laboratory personnel is, of course, the final responsibility of the laboratory supervisor. In a well-organized laboratory, however, a big-brother attitude of higher ranking to lower grade personnel should be encouraged; each person should be eager to share experience, tricks of the trade, special skills, and special knowledge with subordinates. Obviously, efficiency and results will improve.

9.2 Skills

The cost of data production in the analytical laboratory is based largely upon two factors: the pay scale of the analyst, and the number of data units produced per unit of time. However, because of the large variety of factors involved, estimates of the number of measurements that can be made per unit of time are difficult. If the analyst is pushed to

Table 9-1
SKILL-TIME RATING OF STANDARD ANALYTICAL OPERATIONS

Measurement	Skill Required (Rating No.) ¹	Number Per Day
Simple Instrumental:		
pH	1	100-125
Conductivity	1	100-125
Turbidity	1	75-100
Color	1	60-75
Dissolved Oxygen (Probe)	1,2	100-125
Fluoride (Probe)	1,2	100-125
Simple Volumetric:		
Alkalinity (Potentiometric)	1	50-75
Acidity (Potentiometric)	1	50-75
Chloride	1	100-125
Hardness	1	100-125
Dissolved Oxygen (Winkler)	1,2	75-100
Simple Gravimetric:		
Solids, Suspended	1,2	20-25
Solids, Dissolved	1,2	20-25
Solids, Total	1,2	25-30
Solids, Volatile	1,2	25-30
Simple Colorimetric:		
Nitrite N (Manual)	2	75-100
Nitrate N (Manual)	2	40-50
Sulfate (Turbidimetric)	2	70-80
Silica	2	70-80
Arsenic	2,3	20-30
Complex, Volumetric, or Colorimetric:		
BOD	2,3	² 15-20
COD	2,3	25-30
TKN	2,3	25-30
Ammonia	2,3	25-30
Phosphorus, Total	2,3	50-60
Phenol (Distillation Included)	2,3	20-30
Oil and Grease	2,3	15-20
Fluoride (Distillation Included)	2,3	25-30
Cyanide	2,3	8-10
Special Instrumental:		
TOC	2,3	75-100
Metals (by AA), No Preliminary Treatment	2,3	150
Metals (by AA), With Preliminary Treatment	2,3	60-80
Organics (by GC), Pesticides, Without Cleanup	3,4	3-5
Organics (by GC), Pesticides, With Cleanup	3,4	2-4

¹Skill-required rating numbers are defined as follows:

1 – aide who is a semiskilled subprofessional with minimum background or training, comparable to GS-3 through GS-5. (Continued)

produce data at a rate beyond his capabilities, unreliable results may be produced. On the other hand, the analyst should be under some compulsion to produce a minimum number of measurements per unit of time, lest the cost of data production become prohibitive. In table 9-1, estimates are given for the number of determinations that an analyst should be expected to perform on a routine basis. The degree of skill required for reliable performance is also indicated.

The time limits presented in the table are based on use of approved methodology. A tacit assumption has been made that multiple analytical units are available for measurements requiring special equipment, as for cyanides, phenols, ammonia, nitrogen, and COD. For some of the simple instrumental or simple volumetric measurements, it is assumed that other operations such as filtration, dilution, or duplicate readings are required; in such cases the number of measurements performed per day may appear to be fewer than one would normally anticipate.

9.3 Training

For more experienced, higher grade personnel, formal training in special fields, possibly leading to specialization, should be almost mandatory. Such training can be fostered through local institutions and through the training courses provided by the EPA. Regional policies on after-hours, Government-supported training should be properly publicized.

Formalized training for lower grade personnel, comparable to GS-3 to GS-5, is relatively scarce. However, skills can be most efficiently improved at the bench level on a personal, informal basis by more experienced analysts working in the same area. Exposure of personnel to pertinent literature should also be a definite program policy.

(Continued)

- 2 – aide with special training or professional with minimum training with background in general laboratory techniques and some knowledge of chemistry, comparable to GS-5 through GS-7.
- 3 – experienced analyst capable of following complex procedures with good background in analytical techniques, professional, comparable to GS-9 through GS-12.
- 4 – experienced analyst specialized in highly complex procedures, professional, comparable to GS-11 through GS-13.

²Rate depends on type of samples.

WATER AND WASTEWATER SAMPLING

10.1 Introduction

The quality of data resulting from water and wastewater sampling surveys is dependent upon the following six major activities: (a) formulating the particular objectives of the water sampling program, (b) collecting representative water samples, (c) maintaining the integrity of the water samples through proper handling and preservation, (d) adhering to adequate chain-of-custody and sample identification procedures, (e) practicing quality assurance in the field, and (f) properly analyzing the pollutants in the water samples. These areas are equally important for insuring that environmental data are of the highest validity and quality.

The present section addresses aspects of quality control (QC) concerned with the collection of environmental samples and data in the field. It includes a capsule summary of the specific areas mentioned previously and a list of references (table 10-1) that provide specific guidance in these areas, rather than a collection of guidelines on sampling procedures.

10.2 Areas of Sampling

The specific areas that comprise an overall water sampling program are as follows.

10.2.1 Objectives of the Particular Sampling Program

The objectives of the sampling program affect all the other aspects of the sampling program. Sampling program objectives are determined by the following activities: (a) planning (areawide or basin), (b) permitting, (c) compliance, (d) enforcement, (e) design, (f) process control, and (g) research and development. The types of water sampling programs to be employed, depending on suitability to program objectives, include reconnaissance surveys; point-source characterization; intensive surveys; fixed-station-network monitoring; ground-water monitoring; and special surveys involving chemical, biological, microbiological, and radiological monitoring.

Factors that must be considered in meeting the objectives of the sampling program are the extent of the manpower resources, the complexity of the parameters of interest, the duration of the survey, the number of samples, the frequency of sampling, the type of samples (grab or composite), and the method of sample collection (manual or automatic).

10.2.2 Collection of Representative Samples

The objective of all water and wastewater sampling is to obtain a representative portion of the total environment under investigation. The techniques for obtaining representative water samples may vary with the length, width, and depth of a body of water, its physical and chemical parameters, and its type to be sampled (such as municipal or industrial effluents, surface waters and bottom sediments, agricultural runoff, and sludges). In collecting representative samples, the following factors should be considered.

Table 10-1
GUIDANCE FOR WATER/WASTEWATER SAMPLING

Sampling Subject Area	Reference Numbers											
	1	2	3	4	5	6	7	8	9	10	11	12
Objectives of a Sampling Program	X					X	X					
Collection of Representative Samples:	X	X										
Site Selection	X	X					X	X				
Sample Types ¹	X	X				X	X					
Automatic Samplers	X	X		X	X	X	X					X
Flow Measurement	X	X				X	X		X	X		X
Statistical Approach to Sampling:	X											
Frequency of Sampling	X					X						
Number of Samples	X					X						
Probability of Exceeding Standard	X					X						
Special Sampling Procedures:												
Municipal Wastewaters	X											X
Industrial Wastewaters	X											
Agricultural Wastewaters	X											
Surface Waters	X											
Bottom Sediments	X											
Sludges	X											
Biology	X		X				X					
Microbiology	X					X		X				
Radiation	X	X					X	X				
Sample Preservation and Handling:	X	X				X	X	X			X	X
Volume of Sample	X	X									X	
Container Type and Cleaning	X	X										
Sample Identification	X	X						X				
Chain of Custody	X	X						X				
Quality Assurance in the Field		X										

¹Grab, composite, manual, etc.

10.2.2.1 Site Selection

The location of the sampling site is critical in obtaining representative data. Preferably, water sampling sites for point sources of pollution from municipal and industrial effluents are located at points of highly turbulent flow to insure good mixing; however, inaccessibility, lack of site security, or power unavailability may preclude use of the best sites, but these impediments should not be used as reasons for collecting samples at unacceptable locations. Locations of sampling sites for streams, lakes, impoundments, estuaries, and coastal areas vary, but in general occur in the following bodies: (a) in water bodies for sensitive uses (swimming and drinking water supply), (b) in major impoundments or reservoirs near the mouths of major tributaries and in the rivers entering and leaving the impoundments, (c) in water bodies polluted by man's activities, (d) in rivers upstream and downstream from tributaries, and (e) where hydrological conditions change significantly.

10.2.2.2 Types

The basic types of water and wastewater sampling methods are grab sampling and composite sampling. Composite sampling may be conducted manually or automatically. The six methods for forming composite samples, all of which depend on either a continuous or periodic sampling mode, are the following: (a) constant sample pumping rates, (b) sample pumping rates proportional to stream flow rates, (c) constant sample volumes and constant time intervals between samples, (d) constant sample volumes and time intervals between samples proportional to stream flow rates, (e) constant time intervals between samples and sample volumes proportional to total stream flow volumes since last sample, and (f) constant time intervals between samples, and sample volumes proportional to total stream flow rates at time of sampling. The choice of using the grab sampling method or one of the six compositing sampling methods is determined by program objectives and the parameters to be sampled.

10.2.2.3 Automatic Samplers

The use of automatic samplers eliminates errors caused by the human element in manual sampling, reduces personnel cost, provides more frequent sampling than practical for manual sampling, and eliminates the performance of routine tasks by personnel. Criteria for brand selection of automatic samplers include evaluations of the intake device, intake pumping rates, sample transport lines, sample gathering systems (including pumps and scoops), power supplies and power controls, sample storage systems, and additional desirable features to fit particular sampling conditions. There are many commercially available automatic samplers; however, because no single automatic sampler is ideally suited for all situations, the user carefully selects the automatic sampler most suited for the particular water or wastewater to be characterized. Precautions must be taken in regard to using certain types of samples in potentially explosive atmospheres.

10.2.2.4 Flow Measurement

An essential part of any water or wastewater sampling survey as well as a necessary requirement of the National Pollution Discharge Elimination System (NPDES) permit program is accurate flow measurement, which can be divided into four categories:

- a. Flow measurement in completely filled pipes under pressure—common devices employed are orifices, Venturi tubes, flow nozzles, Pitot tubes, magnetic flow meters, ultrasonic flow meters, and elbow meters.

- b. Trajectory methods, either full or partially full, measured at the end of the pipe – common flow measurement methods are the California and Purdue pipe methods. These methods are normally considered as estimates rather than accurate measurements.
- c. Flow measurement in open channels and sewers-common methods are the velocity-area measurement, time-of-passage measurement, and level measurement methods using weirs and flumes.
- d. Miscellaneous flow measurement methods-common methods include use of Manning formula, tracer and salt dilution techniques, water meters, pump rates, and measurements of level changes in tanks and calibrated vessels.

Flow measurement data may be instantaneous or continuous. For continuous measurements, a typical system consists of primary devices such as weirs and flumes and secondary devices such as flow sensors, transmitting equipment, recorders, and totalizers. The improper installation or design of a primary device or malfunction of any part of a secondary device results in erroneous flow data. The accuracy of flow measurement data also varies widely, depending principally on the accuracy of the primary device and the particular flow measurement method used. In any case, an experienced investigator should be able to measure flow rates within ± 10 percent of the true values.

10.2.2.5 Statistical Approach to Sampling

Four factors must be established for every sampling program: (a) number of samples, (b) frequency of sampling, (c) parameters to be measured, and (d) sampling locations. These factors are usually determined in varying degrees by details of the pertinent discharge permits or are more arbitrarily set by the program resource limitations. Nevertheless, the nature of the statistical methods selected and scientific judgment should be used to establish the best procedures.

10.2.2.6 Special Sampling Procedures

Special sampling procedures should be employed for municipal, industrial, and agricultural waters, surface waters as well as bottom sediments and sludges, and for biological, microbiological, and radiological studies.

10.2.3 Sample Preservation and Handling

During and after collection, if immediate analysis is not possible, the sample must be preserved to maintain its integrity. The only legally binding reference EPA has for sample preservation methods is the NPDES permit program specified in reference 13. However, these sample preservation procedures serve as a guide for other program objectives.

Proper handling of the samples helps insure valid data; consideration must also be given to care of the field container material and cap material, cleaning, structure of containers, container preparation for determination of specific parameters, container identification, and volumes of samples.

10.2.4 Chain-of-Custody Procedures

All programs involved in water and wastewater surveys should document and implement a chain of possession and custody of any sample collected, whether or not the resulting data are to be used in enforcement cases. Such procedures insure that the samples are collected, transferred, stored, analyzed, and destroyed only by authorized personnel. See section 12.7 for detailed procedures that can be used on all sample types.

10.2.5 Quality Assurance in the Field

Quality assurance programs for sampling equipment and for field measurement procedures (of such parameters as temperature, dissolved oxygen, pH, and conductance) are necessary to insure data of the highest quality. A field quality assurance program administered by a quality assurance coordinator should contain the following documented elements:

- a. The analytical methodology; the special sample handling procedures; and the precision, accuracy, and detection limits of all analytical methods used.
- b. The basis for selection of analytical and sampling methodology. For example, all analytical methodology for NPDES permits shall be that specified in reference 13, or shall consist of approved alternative test procedures. Where methodology does not exist, the quality assurance plan should state how the new method will be documented, justified, and approved for use.
- c. The amount of analyses for quality control (QC), expressed as a percentage of overall analyses, to assess the validity of data. Generally, the complete quality assurance program should approximate 15 percent of the overall program with 10 and 5 percent assigned to laboratory QC and field QC, respectively. The plan should include a shifting of these allocations or a decrease in the allocations depending upon the degree of confidence established for collected data.
- d. Procedures for the recording, processing, and reporting of data; procedures for review of data and invalidation of data based upon QC results.
- e. Procedures for calibration and maintenance of field instruments and automatic samplers.
- f. A performance evaluation system, administered through the quality assurance coordinator, allowing field sampling personnel to cover the following areas:
 - (1) Qualifications of field personnel for a particular sampling situation.
 - (2) Determination of the best representative sampling site.
 - (3) Sampling technique including location of the points of sampling within the body of water, the choice of grab or composite sampling, the type of automatic sampler, special handling procedures, sample preservation, and sample identification.
 - (4) Flow measurement, where applicable.

- (5) Completeness of data, data recording, processing, and reporting.
 - (6) Calibration and maintenance of field instruments and equipment.
 - (7) The use of QC samples such as duplicate, split, or spiked samples to assess the validity of data.
- g. Training of all personnel involved in any function affecting the data quality.

Quality assurance in sample collection should be implemented to minimize such common errors as improper sampling methodology, poor sample preservation, and lack of adequate mixing during compositing and testing. The checks listed in the following sections will help the quality assurance coordinator to determine when the sample collection system is out of control.

10.2.5.1 Duplicate Samples

At selected stations on a random time frame duplicate samples are collected from two sets of field equipment installed at the site, or duplicate grab samples are collected. This provides a check of sampling equipment and technique for precision.

10.2.5.2 Split Samples

A representative subsample from the collected sample is removed and both are analyzed for the pollutants of interest. The samples may be reanalyzed by the same laboratory or analyzed by two different laboratories for a check of the analytical procedures.

10.2.5.3 Spiked Samples

Known amounts of a particular constituent are added to an actual sample or to blanks of deionized water at concentrations at which the accuracy of the test method is satisfactory. The amount added should be coordinated with the laboratory. This method provides a proficiency check for accuracy of the analytical procedures.

10.2.5.4 Sample Preservative Blanks

Acids and chemical preservatives can become contaminated after a period of use in the field. The sampler should add the same quantity of preservative to some distilled water as normally would be added to a wastewater sample. This preservative blank is sent to the laboratory for analysis of the same parameters that are measured in the sample and values for the blank are then subtracted from the sample values. Liquid chemical preservatives should be changed every 2 weeks-or sooner, if contamination increases above predetermined levels.

10.2.5.5 Precision, Accuracy, and Control Charts

A minimum of seven sets each of comparative data for duplicates, spikes, split samples, and blanks should be collected to define acceptable estimates of precision and accuracy criteria for data validation.

10.2.5.6 Calibration of Field Equipment

Plans should be developed and implemented for calibrating all field analysis test equipment and calibration standards to include the following: (a) calibration and maintenance intervals, (b) listing of required calibration standards, (c) environmental conditions requiring calibration, and (d) a documented record system. Written calibration procedures should be documented and should include mention of the following:

- a. To what tests the procedure is applicable.
- b. A brief description of the calibration procedure. (A copy of the manufacturer's instructions is usually adequate.)
- c. A listing of the calibration standard, the reagents, and any accessory equipment required.
- d. Provisions for indicating that the field equipment is labeled and contains the calibration expiration date.

10.3 References

1. Huibregtse, K. R., and Moser, J. H., Handbook for Sampling and Sample Preservation of Water and Wastewater, EPA-600/4-76-049 (Sept. 1976).
2. Olson, D. M., Berg, E. L., Christensen, R., Otto, H., Ciancia J., Bryant, G., Lair, M. D., Birch, M., Keffer, W., Dahl, T., and Wehner, T., Compliance Sampling Manual, Enforcement Division, Office of Water Enforcement, Compliance Branch (June 1977).
3. Weber, C. I., Biological Field and Laboratory Methods for Measuring the Quality of Surface Waters and Effluents, EPA-670/4-73-001, U.S. EPA (July 1973).
4. Lauch, R. P., A Survey of Commercially Available Automatic Wastewater Samplers, EPA-600/4-76-05 1, U.S. EPA (Sept. 1976).
5. Shelly, P. E., and Kirkpatrick, G. A., An Assessment of Automatic Sewer Flow Samplers, EPA-600/2-75-065, U.S. EPA (Dec. 1975).
6. Handbook for Monitoring Industrial Wastewater, U.S. EPA, Technology Transfer (Aug. 1973).
7. Areawide Assessment Procedures Manual, Vol. II, App. D, EPA-600/9-76-014, U.S. EPA (July 1976).
8. Winter, J. A., Bordner, R., and Scarpino, P., Microbiological Methods for Monitoring the Environment, Part I – "Water and Wastes" U.S. EPA, EMSL, Cincinnati (1977).
9. Water Measurement Manual, 2d Edition (Revised), U.S. Department of the Interior, Bureau of Reclamation (1974).
10. Kulin, G., and Compton, P., A Guide to Methods and Standards for Measurement of Water Flow, Special Publication 421, National Bureau of Standards (May 1975).
11. Methods for Chemical Analysis of Water and Wastewater, U.S. EPA Technology Transfer (1974).
12. Harris, D. J., and Keffer, W. J., Wastewater Sampling Methodologies and Flow Measurement Techniques, EPA-907/9-74-005 (Sept. 1974).
13. Guidelines Establishing Test Procedures for the Analysis of Pollutants, Federal Register, 41, No. 232 (Dec. 1976).

Chapter 11

RADIOCHEMISTRY

11.1 Introduction

The objective of this chapter is to provide general information and suggestions that enable the analyst to execute his responsibilities in analytical quality control (QC) as they relate to radiochemical analyses. Because chemical and radiochemical responsibilities should be considered together, the following requirements could be included with the items specified in the preceding chapters as tasks for the radiochemist: verifying the validity of laboratory data, recommending methodology, interpreting the results, and examining the need for standard procedures.

Environmental radiation measurements are made daily by Federal, State, local, and private agencies. The data obtained from these measurements are used by the U.S. EPA and other agencies for such purposes as estimating doses, describing health effects, establishing standards and guides, and conducting regulatory activities. It is imperative to insure the precision and accuracy of the data, so that policy decisions concerning environmental quality are based on valid and comparable data.

A radiation QC program should be designed to encourage the development and implementation of QC procedures at all levels of sample collection, analysis, data processing, and reporting. It should enable the analyst to verify his analyses and document the validity of the data. In addition, such a program allows the determination of the precision and accuracy of environmental radiochemical analyses.

11.2 Sample Collection

Analytical results can be no more meaningful than the integrity of the samples that are analyzed. Representative samples must be collected so the data for any aliquot can be related to a well-defined pollution source. For most analyses (table 11-1) the sample should be preserved at the sampling site to maintain its integrity and to minimize activity losses from absorption on container walls. If at all possible, analyses should be performed soon after receipt of the samples at the laboratory.

Sample container types and descriptions have already been discussed. Both plastic and glass containers have been recommended, and each has its particular merit. Cost most likely determines which of the many types of plastic containers will be used; in general, those more expensive should be more resistant to adsorption losses. Because sample analyses are recommended soon after collection, less expensive plastic ware can be tolerated. In any event, containers should be discarded after use to prevent contamination of subsequent samples.

Glass bottles are popular items, readily available in all sizes. Although the possibility of breakage either in handling or shipping is obviously great, the very small sizes for radioactive tracer standards and calibration sources can withstand breakage. Use of the larger size bottles for these purposes should therefore be avoided. It is poor economics to ship radioactive samples in fragile glass containers when unbreakable types serve the purpose much better.

Table 11-1
 SAMPLE HANDLING, PRESERVATION, METHODOLOGY, AND MAJOR INSTRUMENTATION REQUIRED¹

Parameter	Sample Preservation ²	Container ³	Instrumentation
Gross Alpha Activity	Concentrated HNO ₃ to pH < 2	P or G	Low-background proportional counter
Gross Beta Activity	Concentrated HNO ₃ to pH < 2	P or G	Low-background proportional counter
Strontium-89	Concentrated HNO ₃ to pH < 2	P or G	Low-background proportional counter
Strontium-90	Concentrated HNO ₃ to pH < 2	P or G	Low-background proportional counter
Radium-226	Concentrated HNO ₃ to pH < 2	P or G	Scintillation cell system
Radium-228	Concentrated HNO ₃ to pH < 2	P or G	Low-background proportional counter
Cesium-134	Concentrated HCl to pH < 2	P or G	Low-background proportional counter
Iodine-131	None	P or G	Low-background proportional counter
Tritium	None	G	Liquid scintillation counter
Uranium	Concentrated HNO ₃ to pH < 2	P or G	Fluorometer
Photon Emitters	Concentrated HNO ₃ to pH < 2	P or G	Gamma spectrometer

¹See reference 1 for method.

²Preservative to be added at the time of collection unless the sample is to be characterized for suspended solids activity.

³P = hard or soft plastic; G = hard or soft glass.

11.3 Laboratory Practices

11.3.1 Laboratory Safety

The general principles of laboratory safety are covered in chapter 14. The hazards to be avoided are listed, and the importance of good housekeeping practices is stressed. These practices reduce the potential hazard of the many chemical operations being performed. In the radiochemical laboratory they eliminate the probability of radiological cross-contamination from sample to sample and from sample to glassware. Many of the materials used in the laboratory are potentially hazardous because of their chemical properties or their radioactivity and therefore should be handled with the utmost care and respect.

In the radiochemical laboratory, the prevention of contamination by radioactive materials requires attention to radiation-protection practices, an ongoing personnel-monitoring program, and the designation of a segregated storage area for radioactive sources following use in radiochemical analyses. Adequate labeling of work areas, of samples for analysis, of aliquots, and of separated fractions helps to control radiation hazards and to insure personnel safety.

The handling of radioactive materials involves safety hazards of a type not usually associated with a chemical laboratory. Special precautions and instruments should be used to insure the greatest personal safety. It is imperative to wear monitoring devices (personal film badges) at all times.

A number of health and contamination hazards are to be considered. Many radioactive materials are dangerous even in extremely minute quantities if inhaled or ingested. All radioactive materials are capable of contaminating laboratories, instruments, and clothing. All radioactive materials in large concentrations are dangerous because of the effects of their radiation external to their containers. To control these hazards, the following rules should be in effect at all times.

- a. For the case of radioactive materials that are capable of being volatilized or airborne, perform all work in a closed area or hood. Perform distillations, evaporations, and other such processes in a well-ventilated hood.
- b. Do not bring food or liquid refreshments into a laboratory engaged in work with radioactive materials. The same applies to the counting rooms.
- c. Do not smoke when handling radioactive materials.
- d. After working with radioactive materials, wash hands thoroughly before eating or handling uncontaminated materials.

11.3.2 Laboratory Analyses

Standard radiochemical procedures or their equivalent are needed to comply with sensitivity detection limits for each nuclide as designated by the quality assurance program (2). Radiochemical procedures have been compiled for a multitude of nuclides in a multitude of media (3-9) and descriptions of specific separations are to be found in the scientific literature. As laboratory techniques become more sophisticated and as more sensitive instrumentation is developed, these procedures will be improved.

Depending on the media, the radioactivity levels, and the nuclide composition, there are several approaches that can be made when a sample is received for QC determination. The requirements for an acceptable QC program are described in section 11.4.

Before starting such a program, the laboratory should be already set up for radiochemical analyses and the analysts should have the prescribed education and experience.

11.3.3 Laboratory Radiation Instruments

The types of radiation counting systems (described in ref. 2) needed to comply with the requirements are set forth in the following paragraphs. Only those instruments needed for analyzing specific radionuclides are required. Such instruments should meet the specifications discussed in the next sections.

11.3.3.1 Liquid Scintillation System

A liquid scintillation system must measure tritium with the sensitivity required by the National Interim Primary Drinking Water Regulations. Efficiency of the system should be greater than 57 percent for tritium. The tritium figure of merit $(E_T)^2/B$ should be greater than 100.

11.3.3.2 Gas-Flow Proportional Counting System or Alternative

A gas-flow proportional counter, or the alternative described later, is required for measurement of gross alpha- and gross beta-particle activities, radium-228, strontium-89, cesium-134, and iodine-131. The detector may be either windowless (internal proportional counter) or of the thin-window type. A minimum shielding equivalent of 5 cm of lead must surround the detector. A cosmic (guard) detector should be operated in anticoincidence with the main detector. The main detector should have an efficiency greater than 20 percent for polonium-210 and carbon-14 and greater than 40 percent for strontium-90. The detector background should be less than 1.3 counts per minute.

The detector plateau should be less than 1.5 percent per 100 V and should be at least 100 V wide for carbon-14 and less than 2 percent per 100 V for strontium-90.

A scintillation system designed for alpha- and beta-particle counting may be substituted for the gas-flow proportional counter described. In such a system a Mylar disk coated with a phosphor (silver-activated zinc sulfide) is either placed directly on the sample (for alpha measurements) or on the face of a photomultiplier tube, enclosed within a light-tight container along with the appropriate electronics (high-voltage supply, amplifier(s), timer, and scaler). Radiation shielding, although desirable, is not required for this system.

11.3.3.3 Gamma Spectrometer System

A sodium iodide (NaI) detector connected to a multichannel analyzer is required for determination of manmade photon emitters. A 7.5- by 7.5-cm NaI crystal is satisfactory; however, a 10- by 10-cm crystal is recommended. The crystal detector must be shielded with a minimum of 10 cm of iron or equivalent.

It is recommended but not required that the distance from the center of the crystal detector to any part on the shield should not be less than 30 cm. The multichannel analyzer, in

addition to the appropriate electronics (high-voltage supply, preamplifier, and linear amplifier), must contain a memory of not less than 200 channels and at least one readout device.

11.3.3.4 Scintillation Cell System

A scintillation system must be designed to accept scintillation flasks (Lucas cells) for measurement of radium-226 by the radon-emanation method. The system consists of a light-tight enclosure for the scintillation flasks, a detector (phototube), and the appropriate electronics (high-voltage supply, amplifier, timers, and scalers). The scintillation flasks required for this measurement may either be purchased from commercial suppliers or constructed according to published specifications.

11.4 Quality Control

The following requirements are recommended for all laboratories:

- a. All QC data should be available for inspection to determine validity of laboratory results.
- b. Each laboratory should participate at least twice each year in EPA laboratory intercomparison studies (10).
- c. Each laboratory should participate once each year in an appropriate EPA-administered performance study on unknowns. Results must be within the control limits established by EPA for each analysis.
- d. Counting-instrument operating manuals and calibration protocols should be available to analysts and technicians.
- e. Calibration data and maintenance records on all radiation instruments and analytical balances must be maintained in a permanent record.
- f. Minimum daily QC
 - (1) To verify precision of methods, a minimum of 10 percent of the samples shall be duplicates. Checks must be within ± 2 standard deviations of the mean range.
 - (2) If less than 20 samples per day are analyzed, a performance standard and a background sample must be measured. If 20 or more samples are analyzed per day, a performance standard and a background sample must be measured with each 20 samples. Checks must be within ± 2 standard deviations of the mean range.
 - (3) Quality control performance charts or performance records must be maintained.

11.5 References

1. Federal Register 41, No. 133 (July 9, 1976).
2. Jarvis, A. N., et al., The Status and Quality of Radiation Measurements of Water, EPA-600/4-76-017 (Apr. 1976).

3. Krieger, H. L., Interim Radiochemical Methodology for Drinking Water, EPA-600/4-75-008 (Revised), U.S. EPA, Office of Research and Development, Cincinnati (Mar. 1976).
4. Doublas, G. S., Editor, Radioassay Procedures for Environmental Samples, Environmental Health Series, Publication 999-RH-27, U.S. DHEW, Public Health Service, National Center for Radiological Health (Jan. 1967).
5. Harley, J. H., HASL Procedures Manual, HASL-300, U.S. ERDA, Health and Safety Laboratory, New York (1972).
6. Kleinberg, J., Editor, Collected Radiochemical Procedures, LA-1721 (Revised), Los Alamos Scientific Laboratory, Los Alamos (Nov. 1955).
7. Krieger, H. L., et al., Radionuclide Analysis of Environmental Samples, Technical Report R59-6 (Revised), U.S. DHEW, Public Health Service (Feb. 1966).
8. Nuclear Science Series, Reports NAS-NS-3001 to NAS-NS-3115, National Academy of Sciences, National Research Council Technical Information Center, Office of Information Services (1960).
9. "Water," Part 31 of 1977 Annual Book of ASTM Standards, American Society for Testing and Materials, Philadelphia (1977).
10. Jarvis, A. N., et al., Environmental Radioactivity Laboratory Intercomparison Studies Program 1975, EPA-680/4-75-002b, U.S. EPA, Office of Research and Development, Las Vegas (1975).
11. Ziegler, L. H., and Hunt, H. M., Quality Control for Environmental Measurements Using Gamma-Ray Spectrometry, U.S. EPA, EPA-600/7-77-144 (Dec. 1977).
12. Kanipe, L. G., Handbook for Analytical Quality Control in Radioanalytical Laboratories, U.S. EPA, EPA-600/7-77-088 (Aug. 1977).

MICROBIOLOGY

12.1 Background

The quality assurance program described in this chapter is a synopsis of a detailed program prescribed in parts IV and V of the EPA microbiological methods manual (1). Quality assurance is a program of integration of all intralaboratory and interlaboratory quality control (QC), methods standardization, and QC management practices into a formal, coordinated, continuing effort.

12.2 Specific Needs in Microbiology

A quality assurance program for microbiological analyses must emphasize the control of laboratory operations and analytical procedures because the tests measure living organisms that continually change in response to their environment. Further, because true values cannot be provided for the microbial parameters, microbiologists do not yet have the advantages of analytical standards, QC charts, and spiked samples available to other disciplines for measurement of accuracy. Because known values cannot be applied, it is important that careful and continuous control be exerted over sampling, personnel, analytical methodology, materials, supplies, and equipment.

12.3 Intralaboratory Quality Control

Intralaboratory QC is the orderly application *within a single laboratory* of laboratory practices necessary to eliminate or reduce systematic error and to control random error. This within-laboratory program must be practical, integrated, and time-efficient or it will be bypassed. When properly administered, such a program helps to insure high-quality data without interfering with the primary analytical functions of the laboratory. This within-laboratory program should be supplemented by participation of the laboratory in an interlaboratory quality assurance program such as that conducted by EPA.

Intralaboratory QC for microbiology should cover the following areas:

- a. Laboratory operations
 - (1) Sample collection and handling
 - (2) Laboratory facilities
 - (3) Laboratory personnel
 - (4) Laboratory equipment and instrumentation
 - (5) Laboratory supplies
 - (6) Culture media
 - (7) Analytical methodology

- b. Analytical QC
 - (1) Sterility checks
 - (2) Positive and negative controls

- (3) Duplicate analyses
- (4) Single-analyst precision
- (5) Comparison of results between analysts
- (6) Verification of membrane filter analyses
- (7) Completion of most probable number analyses
- (8) Data handling

12.4 Interlaboratory Quality Control

An interlaboratory quality assurance program is an agreed-upon system of minimal requirements necessary to maintain a quality standard among a group of laboratories. Such a program may be voluntary or compulsory for participants. It may include the following activities:

- a. Selection and approval of uniform sampling methodology and analytical methodology
- b. Collaborative studies to establish the precision and accuracy of selected methodology
- c. Preparation of guidelines to set minimal group standards for personnel, equipment, instrumentation, facilities, and intralaboratory QC programs
- d. Onsite inspection of laboratory capabilities
- e. Periodic evaluation of laboratory performance on unknown samples
- f. Followup on problems identified in onsite inspections and performance evaluations

As a part of its interlaboratory quality assurance program, EPA has selected microbiological methodology and standards for laboratory operations (1). EMSL-Cincinnati is currently conducting research on the development of QC samples for use in performance testing and method-validation studies.

12.5 Development of a Formal Quality Assurance Program

Unless records are kept of the QC checks and procedures, there is no proof of performance, no value in future reference, and for practical purposes, no quality assurance program in operation. To insure a viable quality assurance program, management must first recognize the need and require the development of a formal program, and then commit 15 percent of the laboratory man-years to QC activities. The laboratory manager holds meetings with supervisors and staff workers to establish levels of responsibility and functions of management, supervisor, and analyst in the quality assurance program. Laboratory personnel participate in planning and structuring the program.

Once the quality assurance program is functioning, supervisors review laboratory operations and QC with analysts on a frequent (weekly) basis. Supervisors use the results of the regular meetings with laboratory personnel to inform management of the status of the program on a regular (monthly) basis. These meetings identify problems through participation of laboratory personnel and provide the backing of management for actions required to correct problems.

12.6 Documentation of a Quality Assurance Program

A laboratory operating manual should be prepared that describes operation, maintenance, and QC of laboratory operations and analyses as practiced. The review mechanisms and the frequency of review in the quality-assurance program are included.

12.6.1 Sampling

A sample log is used to record information on samples received in the laboratory including details of sample identification and origin, the necessary chain-of-custody information, analyses performed, and final results.

12.6.2 Laboratory Operations

A QC record is maintained on media preparation, instrument calibration, purchase of supplies, QC checks on materials, supplies, equipment, instrumentation, facilities, and analyses.

12.6.3 Analytical Quality Control

A record of analytical QC checks is maintained on positive and negative controls, sterility checks, single-analyst precision, precision between analysts, and use-test results from comparison of lots of media, membrane filters, and other supplies.

12.7 Chain-of-Custody Procedures for Microbiological Samples

12.7.1 General

A regulatory agency must demonstrate the reliability of its evidence by proving the chain of possession and custody of any samples that are offered for evidence or that form the basis of analytical test results introduced into evidence in any water pollution case. It is imperative that the office and the laboratory prepare procedures to be followed whenever evidence samples are collected, transferred, stored, analyzed, or destroyed.

The primary objective of these procedures is to create an accurate written record that can be used to trace the possession of the sample from the moment of its collection through its introduction into evidence. A sample is in custody if it is in any one of the following states:

- a. In actual physical possession
- b. In view, after being in physical possession
- c. In physical possession and locked up so that no one can tamper with it
- d. In a secured area, restricted to authorized personnel

Personnel should receive copies of study plans prior to the study of a water pollution case. Prestudy briefings should then be held to apprise participants of the objectives, sample locations, and chain-of-custody procedures to be followed. After the chain-of-custody samples are collected, a debriefing is held in the field to verify the adherence to the chain-of-custody procedures and to determine whether additional samples are required.

12.7.2 Rules for Sample Collection

An agency or laboratory engaged in sample study activities should follow these rules:

- a. Involve a minimum number of trained persons in sample collection and handling.
- b. Establish guidelines for particular procedures to be used for each type of sample collection, preservation, and handling.
- c. Handle samples as little as possible.
- d. Obtain stream and effluent samples using the appropriate sampling techniques.
- e. Attach sample tag or label securely (see fig. 12-1) to the sample container at the time the sample is collected. The tag should contain the following items as a minimum: the serial number of the tag, the station number and location, the date and time taken, the type of sample, the sequence number (e.g., first sample of the day-sequence No. 1), the preservative used, the analyses required, and the name of the sample collector. Tags should be completed legibly in waterproof ink.
- f. Use bound field notebooks to record field measurements and other pertinent information necessary to reconstruct the sample collection processes in the event of a later enforcement proceeding. Maintain a separate set of field notebooks for each study and store them in a safe place where they can be protected and accounted for at all times. Establish a sample log sheet with a standard format to minimize field entries and include the serial number of the sheet, the date, time, survey, type of samples taken, volume of each sample, type of analyses, (unique) sample numbers, sampling location, field measurements (such as temperature, conductivity, dissolved oxygen (DO), and pH), and any other pertinent information or observation. (See fig. 12-2.) The entries should be signed by the sample collector. The responsibility for preparing and retaining field notebooks during and after a study should be assigned to a study coordinator or his designated representative.
- g. The sample collector is responsible for the care and custody of the samples until the samples are properly dispatched to the receiving laboratory or given to an assigned custodian. The sample collector must insure that each container is in his physical possession or in his view at all times, or stored in a locked place where no one can tamper with it.
- h. Take color slides or photographs of the sample locations and any visible water pollution. Sign and indicate time, date, and site location on the back of the photo. To prevent alteration, handle such photographs according to the established chain-of-custody procedures.

12.7.3 Transfer of Custody and Shipment

In transfer-of-custody procedures, each custodian or sampler must sign, record, and date the transfer. Most environmental regulatory agencies develop chain-of-custody procedures tailored to their needs. These procedures may vary in format and language but contain the same essential elements. Historically, sample transfer under chain of custody has been on

U. S. ENVIRONMENTAL PROTECTION AGENCY			
Station No.	Date	Time	Sequence No.
Station Location			_____ Grab _____
Serial Tag No.	<input type="checkbox"/> BOD <input type="checkbox"/> Solids <input type="checkbox"/> COD <input type="checkbox"/> Nutrients	<input type="checkbox"/> Metals <input type="checkbox"/> Oil and Grease <input type="checkbox"/> D.O. <input type="checkbox"/> Bact. <input type="checkbox"/> Other	Remarks/Preservative:
Samplers:			

(a)

ENVIRONMENTAL PROTECTION AGENCY
(Local Address)



(b)

Figure 12-1. Example of chain-of-custody sample tag. (a) Front. (b) Back.

a sample-by-sample basis, which is awkward and time consuming. However, the EPA National Enforcement Investigation Center (NEIC) at Denver has set precedent with its bulk transfer of samples. Bulk transfer is speedier and reduces paperwork and the number of sample custodians. The following description of bulk transfer of custody is essentially that of the Office of Enforcement (2).

- a. Samples must be accompanied by a chain-of-custody record that includes the name of the study, collectors' signatures, station number, station location, date, time, type of sample, sequence number, number of containers, and analyses required. (See fig. 12-3.) When turning over possession of samples, the transferor and transferee sign, date, and time the record sheet. This record sheet allows transfer of custody of a

CHAIN OF CUSTODY RECORD

				SAMPLERS <i>(Signature)</i>					
STATION NUMBER	STATION LOCATION	DATE	TIME	SAMPLE TYPE			SEQ. NO.	NO. OF CONTAINERS	ANALYSIS REQUIRED
				Water		Air			
				Comp.	Grab.				
Relinquished by: <i>(Signature)</i>			Received by: <i>(Signature)</i>					Date/Time	
Relinquished by: <i>(Signature)</i>			Relinquished by: <i>(Signature)</i>					Date/Time	
Relinquished by: <i>(Signature)</i>			Received by: <i>(Signature)</i>					Date/Time	
Received by: <i>(Signature)</i>			Received by Mobile Laboratory for field analysis: <i>(Signature)</i>					Date/Time	
Dispatched by: <i>(Signature)</i>		Date/Time		Received for Laboratory by:				Date/Time	
Method of Shipment:									
<small>Distribution: Orig. – Accompany Shipment 1 Copy – Survey Coordinator Field Files</small>									

Figure 12-3. Example of chain-of-custody record.

group of samples in the field to the mobile laboratory or to the central laboratory. When a custodian transfers a portion of the samples identified on the sheet to the mobile laboratory, the individual samples must be noted in the column with the signature of the person relinquishing the samples. The laboratory person receiving the samples acknowledges receipt by signing in the appropriate column.

- b. If the custodian has not been assigned, the field custodian or field sampler has the responsibility of packaging and dispatching samples to the laboratory for analysis. The dispatch portion of the chain-of-custody record must be filled out, dated, and signed.
- c. To avoid breakage, samples must be carefully packed in shipment containers such as ice chests. The shipping containers are padlocked for shipment to the receiving laboratory.
- d. Packages must be accompanied by the chain-of-custody record showing identification of the contents. The original must accompany the shipment. A copy is retained by the survey coordinator.
- e. If sent by mail, register the package with return receipt requested. If sent by common carrier, a Government bill of lading should be obtained. Receipts from post offices and bills of lading will be retained as part of the permanent chain-of-custody documentation.
- f. If delivered to the laboratory when appropriate personnel are not there to receive them, the samples must be locked in a designated area within the laboratory, so that no one can tamper with them or must be placed in a secure area. The recipient must return to the laboratory, unlock the samples, and deliver custody to the appropriate custodian.

12.7.4 Laboratory Custody Procedures

Suitable laboratory procedures during custody of samples include the following:

- a. The laboratory shall designate a sample custodian and an alternate custodian to act in his absence. In addition, the laboratory shall set aside a sample storage security area. This should be a clean, dry, isolated room with sufficient refrigerator space that can be securely locked from the outside.
- b. Samples should be handled by the minimum possible number of persons.
- c. Incoming samples shall be received only by the custodian who will indicate receipt by signing the chain-of-custody record sheet accompanying the samples and retaining the sheet as a permanent record. Couriers picking up samples at the airport or post office shall sign jointly with the laboratory custodian.
- d. Immediately upon receipt, the custodian places the samples in the sample room, which will be locked at all times except when samples are removed or replaced by the custodian. To the maximum extent possible, only the custodian shall be permitted in the sample room.

- e. The custodian shall insure that microbiological samples are properly stored and maintained at 4°C.
- f. Only the custodian will distribute samples to personnel who are to perform tests.
- g. The analyst records in his laboratory notebook or analytical worksheet, identifying information describing the sample, the procedures performed, and the results of the testing. The notes shall be dated, shall indicate who performed the tests, and should include any abnormalities that occurred during the testing procedure. The notes shall be retained as a permanent record in the laboratory. In the event that the person who performed the tests is not available as a witness at the time of a trial, the Government may be able to introduce the notes in evidence under the Federal Business Records Act.
- h. Approved methods of laboratory analyses shall be used as required by Public Laws 92-500, 93-523, 92-532, and amendments.
- i. Laboratory personnel are responsible for the care and custody of a sample once it is handed to them and should be prepared to testify that the sample was in their possession and view or secured in the laboratory at all times from the moment it was received from the custodian until the tests were run.
- j. The laboratory area shall be maintained as a secured area and shall be restricted to authorized personnel.
- k. Once the sample analyses are completed, the unused portion of the sample, together with identifying labels and other documentation, must be returned to the custodian. The returned, tagged sample should be retained in the custody room until permission to destroy the sample is received by the custodian.
- l. Samples should be destroyed only upon the order of the laboratory director, in consultation with previously designated enforcement officials, or when it is certain that the information is no longer required, or that the samples have deteriorated. The same destruction procedure is true for tags and laboratory records.

12.7.5 Evidentiary Considerations

Reducing chain-of-custody procedures and promulgated analytical procedures to writing will facilitate the admission of evidence under Rule 803 (6) of the Federal Rules of Evidence (Public Law 93-575). Under this statute, written records of regularly conducted business activities may be introduced into evidence as an exception to the hearsay rule without the testimony of the person(s) who made the record. Although it would be preferable, it is not always possible for the individuals who collected, kept, and analyzed samples to testify in court. In addition, if the opposing party does not intend to contest the integrity of the sample or testing evidence, admission under Rule 803(6) can save a great deal of trial time. For these reasons, it is important that the procedures followed in the collection and analyses of evidentiary samples be standardized and described in an instruction manual, which, if need be, can be offered as evidence of the regularly conducted business activity followed by the laboratory or office in generating any given record.

In criminal cases, however, records and reports of matter observed by police officers and other law enforcement personnel are not included under the business record exceptions to the hearsay rule previously cited. (See Rule 803(8), Public Law 93-595.) It is arguable that those portions of the compliance inspection report dealing with matters other than sampling and analysis results come within this exception. For this reason, in criminal actions, records and reports of matter observed by field investigators may not be admissible, and the evidence may still have to be presented in the form of oral testimony by the person(s) who made the record or report, even though the materials come within the definition of business records. In a criminal proceeding, the opposing counsel may be able to obtain copies of reports prepared by witnesses (even if the witness does not refer to the records while testifying), which may be used for cross-examination purposes.

Admission of records is not automatic under either of these sections. The business records section authorizes admission “unless the source of information or the method or circumstances of preparation indicate lack of trustworthiness,” and the caveat under the public records exception reads “unless the sources of information or other circumstances indicate lack of trustworthiness.”

Thus, whether or not the inspector anticipates that a report will be introduced as evidence, the inspector should make certain that the report is as accurate and objective as possible.

12.8 References

1. Winter, J. A., Bordner, R., and Scarpino, P., *Microbiological Methods for Monitoring the Environment, Part I – “Water and Wastes,”* U.S. EPA, EMSL, Cincinnati (1978).
2. *NPDES Compliance Sampling Manual*, U.S. EPA, Office of Water Enforcement (June 1977).

Chapter 13

AQUATIC BIOLOGY

Quality assurance guidelines for aquatic biology programs (fully described in ref. 1) are summarized in the following section.

13.1 Summary of General Guidelines

Successful quality assurance programs in aquatic biology are based, on the following essential elements:

- a. An understanding and acceptance of the importance of quality control (QC) and a commitment on the part of the biology staff to fully integrate QC practices into field and laboratory operations
- b. A staff with adequate formal training and experience and proper specialization to meet program needs
- c. Adequate field equipment, storage and laboratory space, instrumentation, and taxonomic references
- d. Careful advance preparation and design of field and laboratory studies
- e. Strict adherence to approved methodology, where available, and careful consideration of the technical defensibility of the methods and their application
- f. Use of replication in sample collection and analysis where feasible, and determination of the accuracy and precision of the data
- g. Frequent calibration of field and laboratory instruments
- h. Proper sample identification and handling to prevent misidentification or intermixing of samples
- i. Use of blind, split, or other control samples to evaluate performance
- j. Development and regular use of in-house reference specimen collections, and use of outside taxonomic experts to confirm or provide identifications for problem specimens
- k. Meticulous, dual-level review of the results of manual arithmetical data manipulations and transcriptions before the data are used in reports or placed in BIO-STORET (2)
- l. Participation in EPA formal interlaboratory aquatic biology methods studies, and use of EPA biological reference materials
- m. Documentation of methodology and QC practices employed in the program

13.2 Discussion

A brief description of each of the areas mentioned in section 13.1 is provided here to indicate the scope of the quality assurance program.

13.2.1 Staff Commitment

To establish and maintain an effective quality assurance program in aquatic biology, the supervisor must actively support and frequently monitor the use of QC practices in all aquatic biology activities. This will require the commitment of 10 to 15 percent of the total manpower resources. The supervisor must review field and laboratory operations with his staff frequently (weekly) to insure that QC practices are followed and properly documented.

13.2.2 Staff

The quality and reliability of the data rest heavily on the competence of the staff. The range of aquatic organisms studied by biological programs is very broad, and each community requires unique skills in sample collection and analysis, and in data interpretation. Several disciplines, therefore, must be represented on the staff to deal effectively with the taxonomy and ecology of the major groups of aquatic organisms, which include the phytoplankton, zooplankton, periphyton, macrophyton, macroinvertebrates, and fish.

13.2.3 Facilities

The quality of the data also depends upon the availability and performance of laboratory equipment. Such items as sampling gear, current meters, spectrophotometers, and microscopes must be available and must meet performance standards related to the biological parameters measured. Laboratory instrumentation must provide the sensitivity and accuracy required by the state of the art in sample analysis. Adequate laboratory and storage space must also be provided.

13.2.4 Advance Planning

Thorough advance planning of field and laboratory projects is necessary to maintain the required control over the technical aspects of the project and to insure the collection of meaningful data. Factors taken into consideration include the objectives of the study, the parameters to be measured, station selection, the sampling frequency and replication, seasonal cycles in the properties of communities of aquatic organisms, and QC measures to be incorporated into the various phases of the project.

13.2.5 Use of Approved Methodology

Methods in the EPA manual "Biological Field and Laboratory Methods for Measuring the Quality of Surface Waters and Effluents" (1) should be employed where applicable. The manual contains consensus methods selected by a committee of senior Agency aquatic biologists as the preferred methods for use within EPA. If program activities require methods for parameters not covered by reference 1, methods may be selected from other-sources if their application is technically defensible.

13.2.6 Replication

Comparisons of biological parameters measured in control and affected regions of water bodies, and in laboratory experiments, may be meaningless if the precision of the results is not known. Preliminary measurements must be made in each study to determine the scatter in the data and to establish the number of replicate samples required to achieve the level of precision required to detect differences in the responses measured.

13.2.7 Instrument Calibration and Maintenance

Sampling equipment and laboratory instrumentation with mechanical metering devices and electronic components are calibrated on a regularly scheduled basis to insure the accuracy of the data. Standards are obtained, such as NBS-certified thermometers for temperature-measuring devices, class-S weights for balances, and absorption filters for spectrophotometers. Records of calibrations, regular performance checks, and service for each device are maintained in bound log books in such a manner that the history of performance of the instruments may be easily reviewed. Analytical reagents are labeled and dated when received, and are protected from deterioration if labile. The expected shelf life of each reagent is recorded on the label, and the material is not used after the expiration date.

13.2.8 Sample Labeling

Samples are securely labeled in the field and recorded in a bound log. Information on the label should include the station, date, time of day, depth, and other relevant information. A unique lot number is assigned to the sample and recorded on the label. Waterproof paper and ink must be used for the labels, and are recommended for the field logs. Depending on requirements, labels are placed inside samples such as macroinvertebrates.

13.2.9 Quality Control Samples

The accuracy of the data from routine analyses such as counts and identification of organisms and chlorophyll and biomass measurements is determined by introducing blind, split, or reference samples in the sample processing stream. These samples are either prepared by the supervisory aquatic biologist, laboratory quality control officer, or analytical QC coordinator, or are obtained from EMSL-Cincinnati. The results are discussed at regularly scheduled staff meetings and any problems identified are discussed and corrected.

13.2.10 Organism Identification and Reference Specimens

Accurate identification of aquatic organisms to the species level is essential to the interpretation of biological data. A set of reference specimens is established within each laboratory, to be used as taxonomic (identification) standards in processing samples and in training new personnel. The set is representative of the aquatic organisms collected by the program, and each specimen embodies the morphological characteristics essential to the identification of that taxon. The identity of these specimens is verified by outside taxonomic experts, who also examine organisms that pose unusually difficult identification problems in routine sample analysis.

13.2.11 Data Records, Editing (Proofing), Review

Data collected manually are entered in a bound log or on specialized bench sheets that fully describe the origin and nature of the sample and that are maintained in a binder or file. Source data such as organism abundance, metabolic rates, and chlorophyll, which are manually or electronically manipulated or transcribed from one record to another, are doublechecked by a second person. All manual calculations and all electronic calculations, where data are manually keyboarded, are performed twice, except where the source (input) data are included in the output and can be proofed. Keyboarded data are carefully proofed before they are submitted for computer manipulation.

13.2.12 Interlaboratory Methods Studies

The aquatic biology programs participate in formal interlaboratory biological methods studies performed by EMSL-Cincinnati. Studies on chlorophyll and macroinvertebrate identification methods have been completed, and additional studies on phytoplankton and periphyton identification methods are planned in the future.

13.2.13 Documentation for the Quality Assurance Program

A laboratory operations manual is available (1) that describes the scope of the program, organizational structure, qualifications of the staff, available space and equipment, methodology employed for sample collection and analysis, and QC procedures.

13.3 References

1. Weber, C. I., Editor, Biological Field and Laboratory Methods for Measuring the Quality of Surface Waters and Effluents, 2d Edition, EPA-670/4-73-001, U.S. EPA (July 1973).
2. Nacht, L., and Weber, C. I., BIO-STORET Final Design Specification, U.S. EPA (1976).

Chapter 14

LABORATORY SAFETY

14.1 Law and Authority for Safety and Health

Public Law 91-596 is the Occupational Safety and Health Act of 1970 (1). The purpose of this act is the following:

To assure safe and healthful working conditions for working men and women; by authorizing enforcement of the standards developed under the act; by assisting and encouraging the States in their efforts to assure safe and healthful working conditions; by providing for research, information, education, and training in the field of occupational safety and health; and for other purposes.

The intent of the act (1) is “to assure so far as possible every working man and woman in the Nation safe and healthful working conditions and to preserve our human resources.”

The responsibility for promulgating and enforcing occupational safety and health standards rests with the Department of Labor. The Department of Health, Education, and Welfare is responsible for conducting research on which new standards can be based, and for implementing education and training programs for producing an adequate supply of manpower to implement the purposes of the act. These responsibilities are performed by the National Institute for Occupational Safety and Health (NIOSH).

Section 19(a) of Public Law 91-596 states the following (1):

It shall be the responsibility of the head of each Federal agency to establish and maintain an effective and comprehensive occupational safety and health program that is consistent with the standards promulgated under section 6. The head of each agency shall (after consultation with representatives of the employees thereof)-

- (1) provide safe and healthful places and conditions of employment, consistent with the standards set under section 6;
- (2) acquire, maintain, and require the use of safety equipment, personal protective equipment, and devices reasonably necessary to protect employees;
- (3) keep adequate records of all occupational accidents and illnesses for proper evaluation and necessary corrective action;
- (4) consult with the Secretary with regard to the adequacy as to form and content of records kept pursuant to subsection (a)(3) of this section; and
- (5) make an annual report to the Secretary of Labor with respect to occupational accidents and injuries and the agency's program under this section. Such report shall include any report submitted under section 7902(e)(2) of title 5, United States Code.

Executive Order 11807 was issued in the fall of 1974 to provide general direction to the heads of Federal agencies and to the Secretary of Labor in establishing occupational safety and health programs in the Federal Government. The executive order details the following duties:

- a. Appointment of a Safety and Health Official.
- b. Establishment of a management information system.
- c. Establishment of an occupational safety and health program.
 - (1) Adoption of safety and health standards as effective as the Secretary of Labor's standards.
 - (2) Institution of procedures for processing reports from employees on hazardous conditions.
 - (3) Institution of periodic inspection of facilities.
 - (4) Provision for abatement of hazards in facilities.
- d. Provision for training of agency personnel.
 - (1) Training of supervisors at all levels.
 - (2) Training of those responsible for conducting inspections of facilities.
 - (3) Training of other employees. Attention is called to the list of OSHA training requirements.
- e. Assistance of the Secretary of Labor.
 - (1) Compliance with the recordkeeping and reporting requirements.
 - (2) Observation of the guidelines issued in 28 CFR 1960.
 - (3) Cooperation with the Secretary of Labor in the performance of his responsibilities.
- f. Issuance of guidelines for a safety and health program.
- g. Prescription of recordkeeping and reporting requirements.
- h. Provision of consulting services to Federal agencies in adoption of standards, training agency personnel, and in other matters.
- i. Upon request and subject to reimbursement, performance of such services as evaluation of safety and health conditions in the agency, recommendation on the adoption of standards, inspection of facilities for safety and health hazards, and training of agency personnel in safety and health matters.

- j. Evaluation of agency programs and report of the condition to the President. This item in the executive order gives to the Secretary of Labor a degree of enforcement of safety and health rules and regulations within Federal agencies.
- k. Section 4 continues the Federal Advisory Council on Occupational Safety and Health. Note that at least one-third of the members are to be labor representatives.

14.1.1 Occupational Safety and Health Administration Regulations

The Occupational Safety and Health Act of 1970 covers laboratory workplaces as well as industrial and manufacturing workplaces (1). Many large laboratories have already come under the scrutiny of the Occupational Safety and Health Administration (OSHA); small and medium-sized laboratories can expect direct involvement in the future.

The 1970 act set up NIOSH within the U.S. Department of Health, Education, and Welfare. NIOSH provides OSHA with the scientific information it needs to effectively perform its regulatory function.

The initial OSHA regulations were, and in some measure still are, a collection of many well-established standards taken from industry and from standards-making groups. The American National Standards Institute, the National Safety Council, the National Fire Protection Association, and the American Society for Testing and Materials were some of the prime sources for these OSHA standards. Certain existing State health and safety regulations that predated OSHA were used to develop the Federal OSHA regulations.

Efforts are continually underway to refine and quantify current OSHA regulations through court decisions resulting from appeals of compliance citations, through continuing reviews of standards by OSHA safety compliance officers, through the work of NIOSH, and through internal reviews.

Because of the continual publication of revisions of the regulations consisting of refinements and clarifications, as well as dissemination of newly issued regulations, laboratory operators must expend great efforts to keep strictly up to date. What was permitted yesterday may not be permitted today.

The first place to start in keeping up to date on OSHA regulations is to obtain a copy of the Federal or State regulations that apply. In States not operating their own OSHA function, copies of applicable regulations are usually available without charge from the local office of the U.S. Department of Labor. In other States, copies of their regulations are available from similar State offices and boards either free or at a nominal charge. In either case, appropriate steps must be taken to keep up to date on revisions and reissues. Usually this means getting on a mailing list for automatic receipt of this material as it is published. Because entire sections of the regulations may be reissued to incorporate only a few changes, it is usually necessary to completely study these reissues to determine the actual change that has been made.

As OSHA moves more into the complicated areas of chemical and biological laboratory workplaces, the level of the compliance inspector's knowledge must be increased accordingly.

14.1.2 Federal and State OSHA

There is no completely identical OSHA standard in force throughout the United States.

A provision of the act of 1970 permits Federal OSHA to certify individual State OSHA operations when they are satisfied that applicable State regulations and compliance enforcement methods fulfill the provisions of the Federal act (1).

While many State OSHA applications are in process, the following States and territories are certified or at least provisionally certified to permit their own OSHA operation:

- Alaska
- Arizona
- California
- Colorado
- Connecticut
- Hawaii
- Indiana
- Iowa
- Kentucky
- Maryland
- Michigan
- Minnesota
- Nevada
- North Carolina
- Oregon
- South Carolina
- Tennessee
- Utah
- Vermont
- Washington
- Wyoming
- Virgin Islands

All other states and territories are under Federal OSHA jurisdiction.

Even though the Federal Government supports 50 percent of the cost of State OSHA programs, these States apparently would prefer that the Federal Government take on the entire cost burden for them.

An important difference between Federal and State OSHA operations lies in their jurisdictions. While State OSHAs are responsible for State-operated workplaces, Federal OSHA can only inspect Federal workplaces. It cannot enforce compliance. There is, however, a current effort by the General Accounting Office to urge Congress to remove this restriction on Federal OSHA's effectiveness in dealing with Federal workplaces.

While Federal OSHA is not permitted to offer a consulting service, most State OSHAs can and do. Some who were unaware of this difference have called local Federal OSHA offices for advice. All they succeeded in doing was to invite an inspection. Normally, however,

inspections of facilities, be they manufacturing or laboratories, are triggered by an employee's complaint or an accident report, either as required by law or through police, fire, or hospital channels.

Reactions to OSHA operations vary widely. Many laboratories have been cited for violations and have been heavily fined. Yet Dr. David Pettit, Technical Director of Kelco's operations in San Diego, says, "We feel that OSHA standards are not unrealistic, just good laboratory practice."

14.2 EPA Policy on Laboratory Safety

EPA has issued an Occupational Safety and Health Manual (3) in which policy, responsibilities, accident reporting, inspections, standards, and training are described. The Agency has also issued a Safety Management Manual (4) that contains information on safety protection plans at EPA facilities and air, water, and road safety.

The EPA Occupational Safety and Health Manual (3) establishes policy, responsibilities, and procedures for the conduct of the EPA safety and health program.

The policy of EPA is to administer its programs in a manner that assures adequate protection of its own employees and property, and that for which it has a responsibility. *Every* manager, supervisor, and employee is responsible for identifying risks, hazards, and unsafe situations or practices and for taking steps to insure adequate safety in the activities under his supervision.

A facility safety officer designated for each unit must be responsible for assisting the officer-in-charge in developing, organizing, directing, and evaluating the safety and health program and coordinating illness and injury reporting and recordkeeping requirements; analyzing accidents and injuries for prevention and control; and providing technical advice in the implementation of program standards and policy.

Safety in any laboratory requires continuing attention. Use of new or different techniques, chemicals, and equipment requires careful reading, instruction, and supervision, and may require consultation with other people with special knowledge or experience.

Prevention of laboratory accidents requires positive attitudes toward safety and training, and suitable information for understanding laboratory and chemical hazards and their consequences.

Responsibility for safety within the laboratories for an organization may be considered to exist at three different levels-individual, supervisory (or instructional), and organizational (or institutional).

The division of responsibility needs to be clearly assigned and accepted, steps need to be taken to see that the responsibilities are exercised, and the assignments need to be reassessed if unexpected problems develop.

Each individual who works in a laboratory is responsible for learning the health and safety hazards of the chemicals he will be using or producing, and the hazards that may occur from

the equipment and techniques he will employ, so that he can design his setup and procedures to limit the effects of any accident. The individual should investigate any accident that occurs, and record and report the apparent causes and the preventive measures that may be needed to prevent similar accidents.

The supervisor has the responsibility for giving all the necessary directions, including the safety measures to be used, and the responsibility of seeing that employees carry out their individual responsibilities. Whoever directs the activities of others has a concurrent responsibility to prevent accidental injuries from occurring as a result of the activities.

The organization of which the laboratories are part has a fundamental responsibility to provide the facilities, equipment, and maintenance for a safe working environment and to provide an organized program to make the improvements necessary for a safe working environment. Unless the organization fulfills its responsibilities, it cannot expect its supervisors, employees, or students to fulfill their responsibilities for laboratory safety.

The Environmental Protection Agency has a designated safety and health official who is responsible for assuring that formal safety and health inspections are conducted at all EPA workplaces. He will notify the Administrator regarding uncorrected safety and health deficiencies.

14.2.1 Formal Safety Inspections

Formal safety and health inspections at workplaces where there is an increased risk of accident, injury, or illness because of the nature of the work performed, as in the case of chemical operations and material-handling or material-loading operations, must be made by a safety and health specialist. A "Safety and Health Specialist" is defined in 29 CFR 1960.2(h) as a person who meets the Civil Service standards for the position of Safety Manager/Specialist GS-018, Safety Engineer GS-803, Fire Protection Engineer GS-804, Industrial Hygienist GS-690, Fire Protection Specialist/Marshall GS-081, or Health Physicist GS-1306, or who is an employee of an equally qualified military agency or nongovernment organization.

Formal safety and health inspections need not be made by a safety and health specialist at workplaces where there is little risk involved, but should be conducted by a person having sufficient training and experience in the safety and health needs of the workplaces involved to adequately perform the duties of an inspector as set forth in Executive Order 11807. Inspectors should be accompanied on formal safety and health inspections by representatives of the officer in charge of the reporting unit being inspected and representatives of the employees of such establishments. Management and employee representatives should be familiar with and maintain OSHA standards.

To insure safe and healthful working conditions for EPA employees, safety and health inspectors are authorized to enter without delay and at reasonable times, any building, installation, facility, construction site, or other area, workplace, or environment where work is performed by employees of the Agency, to inspect and investigate during regular working hours and at other reasonable times, and within reasonable limits and in a reasonable manner, any such place of employment and all pertinent conditions, structures, machines,

apparatus, devices, equipment, and materials therein; and to question privately any employee, or any supervisory employee, or any officer in charge of a reporting unit.

14.2.2 Informal Safety Inspections

An informal safety and health inspection is performed on either a scheduled or unscheduled basis by the facility safety officer, regional safety officer, supervisory management, or members of a safety and health committee. EPA Form 1440-2, Health and Safety Inspection Checklist (fig. 14-1), shall be used by the inspector or spokesman of a safety and health committee conducting the inspection to note safety and health deficiencies identified during the inspection process.

A more detailed checklist for safety evaluation of the laboratory is given in appendix A. This inspection list contains many specific recommendations and guidelines for laboratory safety.

14.3 Laboratory Safety Practices*

14.3.1 Introduction

14.3.1.1 Safe Use, Handling, and Storage of Chemicals

Chemicals in any form can be safely stored, handled, and used if their hazardous physical and chemical properties are fully understood and the necessary precautions, including the use of proper safeguards and personal protective equipment are observed.

The management of every unit within a manufacturing establishment must give whole-hearted support to a well-integrated safety policy.

14.3.1.2 General Rules for Laboratory Safety

Supervisory personnel should think "safety." Their attitude toward fire and safety standard practices is reflected in the behavior of their entire staff.

A safety program is only as strong as the worker's will to do the correct things at the right time.

The fundamental weakness of most safety programs lies in too much lip service to safety rules and not enough action in putting them into practice.

Safety practices should be practical and enforceable.

Accident prevention is based on certain common standards of education and training of personnel, and provision of safeguards against accidents.

*This description was prepared by Paul F. Hallbach, Chemist, National Training and Operational Technology Center, U.S. EPA, Cincinnati, Ohio 45268.

HEALTH AND SAFETY INSPECTION CHECKLIST					
INSPECTION CONDUCTED BY			TITLE		DATE
NAME/NUMBER OF BUILDING INSPECTED <i>(Use separate form for each building)</i>				REPORTING UNIT	
PART I. PHYSICAL CONDITIONS <i>(Check each applicable item)</i>					
ITEM	SAT	UNSAT	ITEM	SAT	UNSAT
1. HOUSEKEEPING AND SANITATION			18. ELECTRICAL AND ELECTRONIC EQUIPMENT		
2. NON-HAZARDOUS MATERIALS STORAGE			19. WATER <i>(anti-siphone and cross-connections)</i>		
3. HAZARDOUS MATERIALS STORAGE			20. ELECTRICAL <i>(fuses, grounding, etc.)</i>		
4. MATERIALS HANDLING EQUIPMENT			21. COMPRESSED GAS CYLINDERS		
5. AISLES AND WALKWAYS			22. STRUCTURAL CONDITION OF BUILDING		
6. LADDERS AND STAIRS			23. PARKING AREA		
7. FLOORS, PLATFORMS AND RAILINGS			24. MOTOR VEHICLES		
8. EGRESS			25. PORTABLE TOOLS		
9. LIGHTING			26. PROTECTIVE CLOTHING AND EQUIPMENT		
10. VENTILATION			27. HAZARDOUS WARNING SIGNS		
11. FLAMMABLE OR NOXIOUS DUST OR VAPORS			28. EMISSION OF POLLUTANTS <i>(air, fluid, solids)</i>		
12. HAZARDOUS BIOLOGICAL AGENTS			29. OCCUPATIONAL NOISE EXPOSURE		
13. FIRE DETECTION DEVICES			30. MEDICAL SERVICES, INCLUDING FIRST AID		
14. FIRE ALARM SYSTEM			31. PROVISIONS FOR HANDICAPPED		
15. FIRE SUPPRESSION <i>(Including extinguishers)</i>			32. OTHER		
16. MECHANICAL EQUIPMENT					
17. MACHINE GUARDS AND SAFETY DEVICES					
PART II. PROCEDURES AND INSTRUCTIONS <i>(Check each applicable item)</i>					
33. MATERIALS HANDLING			45. FIELD OPERATIONS, OTHER		
34. MOTOR VEHICLE OPERATION			46. SAFETY COMMITTEE ACTIVITY		
35. BUILDING MAINTENANCE			47. FEDERAL SAFETY COUNCIL PARTICIPATION		
36. EQUIPMENT MAINTENANCE			48. EMPLOYMENT REPRESENTATION IN SAFETY AND HEALTH PROGRAM		
37. USE OF PROTECTIVE CLOTHING AND EQUIPMENT			49. JOB ORIENTATION		
38. HAZARD MONITORING EQUIPMENT <i>(carbon monoxide, radiation, etc.)</i>			50. JOB TRAINING, INCLUDING SAFETY AND HEALTH		
39. FACILITY SELF-PROTECTION PLAN			51. SAFETY PROMOTIONAL AND MOTIVATIONAL ACTIVITIES		
40. LABORATORY OPERATIONS			52. PERIODIC PHYSICAL EXAMINATIONS		
41. BOATING OPERATIONS			53. OTHER		
42. DIVING OPERATIONS					
43. AVIATION OPERATIONS					
44. CRAFTS AND SHOPS OPERATIONS					
REMARKS <i>(Continue on back if necessary)</i> (NOTE: Use EPA Form 1440-6 to document in detail each unhealthful or unsafe condition)					

EPA Form 1440-2 (Rev. 5-77)

PREVIOUS EDITION MAY BE USED UNTIL SUPPLY IS EXHAUSTED

Figure 14-1. Health and safety inspection checklist.

14.3.2 Laboratory Design and Equipment

14.3.2.1 Type of Construction

The construction of the laboratory should generally be fire resistant or noncombustible.

Multiple story buildings should have adequate means of exit.

Stairways should be enclosed with brick or concrete walls.

Laboratories should have adequate exit doors to permit quick, safe escape in an emergency and to protect the occupants from fires or accidents in adjoining rooms. Each room should be checked to make sure there is no chance of a person being trapped by fire, explosions, or release of dangerous gases.

Laboratory rooms in which most of the work is performed with flammable liquids or gases should be provided with explosion-venting windows.

14.3.2.2 Arrangement of Furniture and Equipment

Furniture should be arranged for maximum use of available space and should provide working conditions that are efficient and safe.

Aisles between benches should be at least 4 ft wide to provide adequate room for passage of personnel and equipment.

Desks should be isolated from benches or adequately protected.

Every laboratory should have an eyewash station and a safety shower.

14.3.2.3 Hoods and Ventilation

Adequate hood facilities should be installed where highly toxic or highly flammable materials are used.

Hoods should be ventilated separately and the exhaust should be terminated at a safe distance from the building.

Makeup air should be supplied to rooms or to hoods to replace the quantity of air exhausted through the hoods.

Hood ventilation systems are best designed to have an airflow of not less than 60 ft/min (linear) across the face of the hood with all doors open, and 150 ft/min (linear) if toxic materials are involved.

Exhaust fans should be sparkproof if exhausting flammable vapors and corrosive resistant if handling corrosive fumes.

Controls for all services should be located at the front of the hood and should be operable when the hood door is closed.

All laboratory rooms should have the air changed continuously at a rate depending on the materials being handled.

Recent California OSHA regulations require the presence of a means of visual indication of the existence of the airflow in the hood and specify the height and type of hood exhaust permitted.

14.3.2.4 Electrical Services

Electrical outlets should be placed outside of hoods to afford easy access and thus protect them from spills and corrosion by gases.

Noninterchangeable plugs should be provided for multiple electrical services.

Adequate outlets should be provided and should be of the three-pole-type to provide for adequate grounding.

Rubber or nonconductive composition shoe soles should be required (except when flammable vapors are present). Shoe soles should not be of a type that readily absorbs water or other liquids.

14.3.2.5 Storage

Laboratories should provide for adequate storage space for mechanical equipment and glassware that will be used regularly.

Flammable solvents should not be stored in glass bottles over 1 l in size. Large quantities should be stored in metal safety cans. Quantities requiring containers larger than 1 gal should be stored outside the laboratory.

Explosion proof refrigerators should be used for the storage of highly volatile and flammable solvents.

Cylinders of compressed or liquefied gases should not be stored in the laboratory.

Alphabetized storage of chemicals should be avoided to prevent the unintentional mixing of two incompatible chemicals in an accident situation.

An appropriate antidote must be readily available for every stored chemical compound for which an antidote is specified.

14.3.2.6 Housekeeping

Housekeeping plays an important role in reducing the frequency of laboratory accidents. Rooms should be kept in a neat and orderly condition. Floors, shelves, and tables should be kept free from dirt and from all apparatus and chemicals not in use.

A cluttered laboratory is a dangerous place to work. Maintenance of a clean and orderly work space is indicative of interest, personal pride, and safety-mindedness.

Passageways should be kept clear to all building exits and stairways.

Metal containers should be provided for the disposal of broken glassware and should be properly labeled.

Separate approved waste disposal cans should be provided for the disposal of waste chemicals.

Flammable liquids not miscible with water and corrosive materials or compounds that are likely to give off toxic vapors should never be poured into the sink.

Laboratory operators must be sure that unguarded rotating equipment such as belt-driven vacuum pumps is provided with guards all the way around and that the guards are always in place.

Whenever heavy laboratory equipment must be moved frequently, rollers should be provided. In other cases, proper lifting equipment should be available.

14.3.2.7 Fire Protection

Laboratory personnel should be adequately trained regarding pertinent fire hazards associated with their work.

Personnel should know rules of fire prevention and methods of combating fires.

Fire extinguishers (CO₂ type) should be provided at convenient locations and personnel should be instructed in their use.

Automatic sprinkler systems are effective for the control of fires in chemical laboratories.

14.3.2.8 Alarms

An *approved* fire-alarm system should be provided.

Wherever a hazard of accidental release of toxic gases exists, a gas alarm system to warn occupants to evacuate the building should be provided.

Gas masks of oxygen or compressed-air-type should be located near exits and selected personnel trained to use them.

14.3.3 Handling Glassware

14.3.3.1 Receiving, Inspection, and Storage

Packages containing glassware should be opened and inspected for cracked or nicked pieces, pieces with flaws that may become cracked in use, and badly shaped pieces.

Glassware should be stored on well-lighted stockroom shelves designed and having a coping of sufficient height around the edges to prevent the pieces from falling off.

14.3.3.2 Laboratory Practice

Select glassware that is designed for the type of work planned.

To cut glass tubing or a rod, make a straight, clean cut with a cutter or file at the point where the piece is to be severed. Place a towel over the piece to protect the hands and fingers, then break away from the body.

Large size tubing is cut by means of a heated nichrome wire looped around the piece at the point of severance.

When it is necessary to insert a piece of glass tubing or a rod through a perforated rubber or cork stopper, select the correct bore so that the insertion can be made without excessive strain.

Use electric mantels for heating distillation apparatus, etc.

To remove glass splinters, use a whisk broom and a dustpan. Very small pieces can be picked up with a large piece of wet cotton.

14.3.4 Gases and Flammable Solvents

14.3.4.1 Gas Cylinders

Large cylinders must be securely fastened so that they cannot be dislodged or tipped in any direction.

Connections, gages, regulators, or fittings used with other cylinders must not be interchanged with oxygen cylinder fittings because of the possibility of fire or explosion from a reaction between oxygen and residual oil in the fitting.

Return empty cylinders promptly with protective caps replaced.

14.3.4.2 Flammable Solvents

Store in well-ventilated designated areas.

Flash point: the temperature at which a liquid gives off vapor sufficient to form an ignitable mixture with the air near the surface of the liquid or within the vessel used.

Ignition temperature: the minimum temperature required to initiate or cause self-sustained combustion independently of the heating or heated element.

Explosive or flammable limits: for most flammable liquids, gases, and solids there is a minimum concentration of vapor in air or oxygen below which propagation of flame does not occur on contact with a source of ignition. There is also a maximum proportion of vapor or gas in air above which propagation of flame does not occur. These limit mixtures of vapor or gas with air, which if ignited will just propagate flame, are known as the "lower and higher explosive or flammable limits."

Explosive range: the difference between the lower and higher explosive or flammable limits, expressed in terms of percentage of vapor or gas in air by volume.

Vapor density: the relative density of the vapor as compared with air.

Underwriter's Laboratories classification: a standard classification for grading the relative hazard of the various flammable liquids. This classification is based on the following scale:

Ether class	100
Gasoline class	90 to 100
Alcohol (ethyl) class	60 to 70
Kerosene class	30 to 40
Paraffin oil class	10 to 20

Extinguishing agents that are appropriate for each of the four classes of fires are required.

14.3.5 Chemical Hazards

14.3.5.1 Acids and Alkalies

Some of the most hazardous chemicals are the strong or mineral acids such as hydrochloric, hydrofluoric, sulfuric, and nitric.

Organic acids are less hazardous because of their comparatively low ionization potentials; however, such acids as phenol (carbolic acid), hydrocyanic, and oxalic are extremely hazardous because of their toxic properties.

Classification of acids is according to mineral or organic composition. Acids should be stored together, except that perchloric acid should not be placed next to glacial acetic acid. Picric acid should be stored separately.

14.3.5.2 Oxidizing Materials

Oxidizing agents, in contact with organic matter, can cause explosions and fire. They are exothermic and decompose rapidly, liberating oxygen, which reacts with organic compounds.

Typical hazardous oxidizing agents are-

- Chlorine dioxide
- Sodium chlorate; chlorates
- Potassium chromate
- Chromium trioxide
- Perchloric acid; perchlorates

14.3.5.3 Explosive Power

Many chemicals are explosive or form compounds that are explosive and should be treated accordingly.

A few of the more common examples of this class of hazardous materials are-

- Acetylides
- Silver fulminate

Peroxides
Peracetic acid
Nitroglycerine
Picric acid
Chlorine and ethylene
Sodium metal
Calcium carbide

14.3.5.4 Toxicity

Laboratory chemicals improperly stored or handled can cause injury to personnel by virtue of their toxicity.

There are four types of exposure to chemicals:

- a. Contact with the skin and eyes
- b. Inhalation
- c. Swallowing
- d. Injection

Special classes of toxic agents:

- a. Carcinogens-laboratory operators should recheck the OSHA 1974 regulations on carcinogens.
- b. Mercury-complete cleaning of spills is essential for compliance with OSHA limits.

14.3.6 Precautionary Measures

14.3.6.1 Clothing and Personal Protective Equipment

Chemical laboratories should have special protective clothing and equipment readily available for emergency use and for secondary protection of personnel working with hazardous materials.

Equipment should be provided for adequate-

- a. Eye protection
- b. Body protection
- c. Respiratory protection
- d. Foot protection
- e. Hand protection

14.3.6.2 Bodily Injury

Burns, eye injuries, and poisoning are the injuries with which laboratory people must be most concerned.

First emphasis in the laboratory should be on preventing accidents. This means observing all recognized safe practices using necessary personal protective equipment and exercising proper control over poisonous substances at the source of exposure.

So that a physician can be summoned promptly, every laboratory should post the names, telephone numbers, and addresses of doctors to be called in an emergency requiring medical care.

A consulting physician should specify the type and extent of first aid materials required for the laboratory.

14.4 Report of Unsafe or Unhealthful Condition

In EPA a procedure has been established for reporting an unsafe or unhealthful condition by the employee or supervisor. The procedure also provides for communication between the employees; supervisors; safety official; head of the unit; and, in the case of an unresolved report, the Department of Labor.

A sample of an unsafe or unhealthful condition reporting form is shown in figure 14-2, and sample notice of an unhealthful or unsafe condition is shown in figure 14-3.

14.5 References

1. Public Law 91-596, Occupational Safety and Health Act of 1970 (Dec. 29, 1970).
2. Occupational Safety and Health Manual, U.S. EPA (Jan. 8, 1976).
3. Safety Management Manual, U.S. EPA, TN 1440.1 (Dec. 4, 1972).

RNN1440.011		
REPORT OF UNHEALTHFUL OR UNSAFE CONDITION		
TO:		FROM:
BRIEF DESCRIPTION OF UNHEALTHFUL OR UNSAFE CONDITION		
OCCUPATIONAL SAFETY AND HEALTH STANDARD VIOLATED (If known)		LOCATION (Include organization, Facility and Building)
ACTION TAKEN BY SUPERVISOR		
SIGNATURE	EMPLOYING ORGANIZATION	DATE
<small>EPA Form 1440-6 (Rev. 5-77) PREVIOUS EDITION MAY BE USED UNTIL SUPPLY IS EXHAUSTED. NOTE: A COPY OF THIS FORM MUST BE RETAINED BY THE ORIGINATOR</small>		

Figure 14-2. Report of unhealthful or unsafe condition.

NOTICE OF UNHEALTHFUL OR UNSAFE WORKING CONDITION				
TO (Name of Officer-in-Charge of Reporting Unit):		FROM (Name of Inspector):		
REPORTING UNIT		Occupational Health and Safety Office Washington, D.C. 20460		
An inspection conducted by me on _____ at _____ revealed the following violation(s) of EPA Occupational Health and Safety Standards. These Standards have been adopted in compliance with the Occupational Safety and the Health Act of 1970, PL 91-956, Section 19.				
ITEM NO.	STANDARD, REGULATION OR SECTION VIOLATED	DESCRIPTION OF VIOLATION	LOCATION OF VIOLATION	NO. OF WORKING DAYS BY WHICH VIOLATION MUST BE CORRECTED AND DATE
<p>Subpart D of 29CFR 1960.33, Safety and Health Provisions for Federal Employees, requires that a copy of this Notice shall be posted <i>immediately</i> in a prominent place at or near each place that the violation(s) referred to in the Notice occurred. The Notice must remain posted until all violations cited therein are corrected, or for three (3) working* days, whichever period is longer. A copy of this Notice shall be sent to the Health and Safety Committee of the establishment or Reporting Unit and to any person(s) who made a report of the unhealthful or unsafe condition which precipitated this inspection pursuant to the provisions of 29CFR 1960.31.</p> <p>Subpart D of 29CFR 1960.34 requires the Officer-in-Charge of the Reporting Unit to <i>immediately</i> submit an abatement plan to the Designated Agency Safety and Health Official, if, in his judgment, the correction of the violation will not be possible within thirty (30) working days*. Such plan shall contain an explanation of the circumstances of the delay in abatement; a proposed timetable for the abatement, and a summary of steps being taken in the interim to protect employees. A copy of the plan shall be sent to the Health and Safety Committee of the establishment or Reporting Unit and to any person(s) who made a report of the unhealthful or unsafe condition which precipitated this inspection pursuant to the provisions of 29CFR 1960.31.</p> <p>*Under the Occupational Safety and Health Act, the term "Working Day" means Monday through Friday but does not include Saturday, Sunday, or Federal Holidays.</p>				
SIGNATURE OF HEALTH AND SAFETY OFFICER				DATE

EPA Hq Form 1440 8 (8-77)

Figure 14-3. Notice of unhealthful or unsafe condition.

APPENDIX A

SUGGESTED CHECKLIST FOR THE SAFETY EVALUATION OF EPA LABORATORY AREAS

Organization: _____ Date: _____
 Location: _____ Building: _____
 Room(s): _____ By: _____

Item Inspected	Yes	No	N.A.	Comments
<i>Fire Prevention</i>				
1. Is fire alarm facility available? [.36(b)(7)]				
2. Are all exits maintained to provide free and unobstructed egress from all parts of building? [.36(b)(4)]				
3. Are all exits free of locks or fastening devices that could prevent free escape? [.36(b)(4)]				
4. a. Is the fire detection system in working order? b. Is the sprinkler system in working order? c. Are fire doors in working order? [.36(d)(2)]				
5. Are corridors and hallways at least 44 in wide? [.37(h)(1)]				
6. Do all exits discharge directly to a street, yard, court, or other open space? [.37(h)(1)]				
7. Are all exits marked by proper sign and illuminated? Are letters in sign not less than 6 in high, 3/4 in wide? [.37(q)(8)]				
8. Is access to exits marked in all cases where the exit or the way to reach it is not immediately visible? [.37(q)(5)]				
9. Is care taken to insure that no exit signs are obscured by decorations, furniture, or equipment? [.37(q)(3)]				
10. Is exit access arranged so that it is not necessary to travel toward any high hazard area to escape? [.37(f)(5)]				

Note: Adapted from a safety inspection work sheet developed by the Center for Disease Control (CDC). The pertinent section of the Code of Federal Regulations, title 29, part 1910 is given within brackets at the end of each item.

Listed below are explanations given by OSHA to questions that are not immediately clear on the safety checklist for laboratory areas. Each explanation is numbered according to the corresponding question on the facing page.

1. Self-explanatory.
2. Self-explanatory.
3. At no time should an exit door be locked or fastened in a manner that prevents it from being *immediately* opened from the inside of the building in the event of emergency. Safety inspectors should check all doors marked "EXIT" to insure that they can be readily opened.
- 4a,b. The building manager should conduct periodic tests (as recommended by the manufacturer or as required by local code) to insure proper working order of the fire detection system and the automatic sprinkler system.
- 4c. Fire doors are designed to be closed in the event of fire. Automatic fire doors normally remain open; however, the heat produced by a fire will cause them to close. Regular fire doors are designed to stay closed at all times, except for the passage of personnel. *No fire door should ever be blocked open as this will interfere with its function.* Fire doors are typically used to enclose stairways and to separate buildings and corridors.
5. Self-explanatory.
6. An exit should never discharge into a location that could potentially trap personnel. For example, an exit should not discharge into a closed courtyard.
7. Self-explanatory.
8. A sign reading "EXIT" or similar designation, with an arrow indicating the direction, shall be placed in every location where the direction of travel to reach the nearest exit is not immediately apparent.
9. Self-explanatory.
10. In designing and maintaining exit routes from a building, care should be taken to avoid routing people through or near a high hazard area. An example of a high hazard area is a corridor or room where flammable liquids are stored.

Item Inspected	Yes	No	N.A.	Comments
11. Are aisles maintained clear and unobstructed for movement of personnel and fire-fighting equipment? [.22(b)(1)]				
12. Is all fire protection equipment and apparatus identified with the color red? [.144(a)(1)]				
13. Are portable fire extinguishers maintained fully charged and operable and kept in designated places at all times? [.157(a)(1)]				
14. Are fire extinguishers conspicuously located, readily accessible, and available along normal paths of travel? [.157(a)(2)]				
15. Are extinguishers and locations conspicuously marked to indicate intended usage? [.157(a)(4)]				
16. Are extinguishers mounted so that the top is not more than 5 ft above floor; not more than 3½ ft if weight equals more than 40 lb? [.157(a)(6)]				
17. Are all extinguishers mounted in cabinets placed so that the instructions face outward? [.157(a)(7)]				
18. Are extinguishers available suited to the class of fire anticipated in each area? [.157(b)(1)]				
19. Are extinguishers placed according to distances for proper coverage? Within 75 ft – class A. Within 50 in – class B. [.157(c)]				
20. Are extinguishers inspected, maintained, and replaced by spares when they are discharged or missing? [.157(d)]				
21. Are laboratory rooms with potential fire hazards equipped with proper extinguishers for emergency situations? [.157(b)]				
22. If flammable liquids are used in a laboratory, is the mechanical ventilation sufficient to remove vapors before they reach a hazardous concentration? [.106(e)(2)(iii)]				

11. Self-explanatory.
12. Self-explanatory.
13. Self-explanatory. During a safety inspection all fire extinguishers should be checked against the requirements of this question.
14. Fire extinguishers should *never* be located in places where they are concealed from general view.
15. Fire extinguishers must be clearly labeled to indicate the type of fire they are capable of fighting. The following code is used to classify types of fires:
 - Class A* – fires in ordinary combustibles such as wood, cloth, paper and rubber
 - Class B* – fires in flammable liquids, gases, and greases
 - Class C* – fires that involve energized electrical equipment where the electrical nonconductivity of the extinguishing medium is of importance; when electrical equipment is deenergized, extinguishers for class A or B fires may be safely used
 - Class D* – fires in combustible metals such as magnesium, titanium, zirconium, sodium, and potassium
16. Inspector should make certain that no fire extinguishers (other than wheeled-type extinguishers) are placed on the floor.
17. Self-explanatory.
18. See explanation to question No. 15 for classification of fire hazards. Fire extinguishers (of more than one type, if necessary) should be selected and located according to anticipated fire hazards.
19. Self-explanatory.
20. Self-explanatory.
21. In certain instances, laboratories can be fire traps. When this is the case, fire extinguishers should be provided *inside* the laboratory so that occupants can fight their way out of a fire emergency. Safety inspectors should check for escape routes to the nearest corridor when considering this question.
22. Self-explanatory.

Item Inspected	Yes	No	N.A.	Comments
23. Are hose outlets within easy reach of persons standing on floor and not over 6 ft from floor? [.158(b)(1)(i)]				
24. Do all connections on dry standpipes have a sign reading "DRY STANDPIPE-FOR FIRE DEPARTMENT USE ONLY"? [.158(b)(7)]				
25. Are automatic sprinkler systems provided with at least one fire department connection with at least 4-in pipe size? [.159(b)(1)]				
26. Are fire department connections designated "AUTO SPKR" or "OPEN SPKR"? [.159(b)(4)(v)]				
27. Is there a water flow detection device on the sprinkler system that will activate the fire alarm? [.159(c)(1)]				
28. Are fire alarm boxes readily accessible and within normal path distance of 200 ft? [.163(b)(3)]				
29. Are all fire alarm systems inspected and tested at weekly intervals? [.163(c)]				
30. Are "NO SMOKING" signs posted in prohibited areas? [.106(d)(7)(iii)]				
<i>Flammable Liquid Storage</i>				
31. Are drums which contain flammable liquids constructed of noncombustible materials? [.106(b)(1)(i)]				
32. Are storage drums vented? [.106(b)(2)(iv)]				
33. Are flammable liquids stored in proper containers? [.106(d)(2)(i)]				
34. Are safety cans and portable containers of flammable liquids painted red with yellow band or name of contents? [.144(a)(1)(ii)]				
35. Are storage cabinets being used for storing flammable liquids? [.106(d)(3)]				
36. Are storage cabinets labeled "FLAMMABLE-KEEP FIRE AWAY"? [.106(d)(3)(ii)]				

23. This question applies to buildings equipped with water and hose standpipe systems. Hose outlets are normally located in stairways or in the corridor immediately outside the stairway.
24. Self-explanatory. The building manager should be able to answer this question.
25. Fire department connections to automatic sprinkler systems are normally located on the outside of the building being protected. The size of the connection is usually embossed on a metal plate or on the connection itself.
26. The designations "ALTTTO-SPKR" or "OPEN-SPKR" are found embossed on a plate at the fire department connection. Failure to display one of the designations is a violation of OSHA.
27. This question is self-explanatory. The building manager should know if the facility is equipped with a sprinkler waterflow detection device.
28. Self-explanatory.
29. This procedure should be part of a regular maintenance program.
30. The laboratory supervisor shall designate areas where smoking is prohibited and "NO SMOKING" signs shall be placed in these areas.
31. Flammable liquid storage drums should be constructed of steel or some other noncombustible material.
32. Self-explanatory.
33. Flammable liquids may be safely stored in glass containers if the total capacity of the container is 1 gal or less. Larger quantities of flammable liquids should be stored in safety cans approved by a recognized testing laboratory.
34. Self-explanatory.
35. Self-explanatory.
36. Self-explanatory.

Item Inspected	Yes	No	N.A.	Comments
37. Is the storage area provided with either a gravity or mechanical exhaust ventilation system? [.106(d)(4)(iv)]				
38. Are extinguishers available where flammable or combustible liquids are stored? [.106(d)(7)]				
39. Is at least one portable fire extinguisher of rating not less than 12-B units located outside of, but not more than 10 ft from, door opening into room used for storage? [.106(d)(7)(i)(a)]				
40. Is at least one portable fire extinguisher with rating not less than 12-B units located not less than 10 ft nor more than 25 ft from flammable liquid storage located outside of a storage room but inside of a building? [.106(d)(7)(i)(b)]				
41. Are "NO SMOKING" signs posted in the flammable or combustible liquid storage areas? [.106(d)(7)(iii)]				
<i>Electrical Hazards</i>				
42. Are all new electrical installations and all replacements, modifications, or repairs made and being maintained in accordance with the National Electrical Code? [.309]				
43. Does the interior wiring system have a grounded conductor? i.e., three-wire system? [.309-NEC(200-2)]				
44. Do all electrical appliances have Underwriter's Laboratories Inc. approval, or that of some other nationally recognized testing laboratory? [.309-NEC(90-8)]				
45. Are the cords of all electrical equipment in good condition, not frayed or spliced, etc.? [.309-NEC(400-5)]				
46. Are cords used properly (not run under rugs)? [.309-NEC(4004)]				
47. Is there only one plug-in per socket outlet; i.e., no multiple plug-ins to one socket? [.309-NEC(240-2)]				
48. Are the lighting levels such that good illumination is provided in all walking, working, and service areas to insure safety? [.309-NEC(110-16(e))]				

37. The building manager or engineering department should know the answer to this question.
38. Self-explanatory. Fire extinguishers approved for fighting class B fires should be available in flammable liquids storage areas.
39. This question is self-explanatory but should be reread several times for full comprehension. Fire extinguisher ratings are often stamped on the title plate along with other specifications. *Note: This question is to be used only when inspecting flammable-liquid storage rooms.*
40. This question is self-explanatory, but should be reread several times for full comprehension. *Note: This question is to be used only when inspecting flammable liquid storage outside of a special designated room, but inside of a building.*
41. Self-explanatory.
42. Prior to adding any new electrical facilities to a laboratory, it is the responsibility of the laboratory supervisor or building manager to check with the electrical contractor to insure that the National Electrical Code is observed. This rule is retroactive to Mar. 15, 1972.
43. All convenience outlets shall be of the three-pronged type. These outlets should be checked with a grounding tester to insure proper wiring.
44. Approved appliances will bear the label of a recognized testing laboratory.
45. Self-explanatory.
46. Self-explanatory.
47. Multiple outlet (cube) adaptors or extension cords with multiple outlet ends should not be used to plug more than one appliance into a single socket.
48. Self-explanatory.

Item Inspected	Yes	No	N.A.	Comments
49. Are circuit breaker panels and cutoff switches located so as to be readily accessible? [.309-NEC(240-25(b)) and (1926.400(e))]				
50. Are all circuit breaker switches marked or labeled? [.309-NEC(240-25(e))]				
<i>Aisles, Exits, Floors, and Stairways</i>				
51. Are all floors kept clean and dry? [.22(a)(2)]				
52. Are all floors, areas, and passageways free from protruding nails, splinters, holes, and loose boards? [.22(a)(3)]				
53. Are aisles and passageways clear of all obstructions and in good repair? [.22(b)(1)]				
54. Are aisles and passageways wide enough to operate equipment safely? [.22(b)(1)]				
55. Is floor loading within <i>posted</i> maximum limits? [.22(d)]				
56. Does every floor opening having standard guarded railings? [.23(a)(1)]				
57. Do fixed stairs make an angle to the horizontal between 30° to 50°? [.24(e)]				
58. Are all opensided floors, platforms, ramps, 4 ft above adjacent floor or ground, guarded with railing? [.23(c)(1)]				

- 49. Circuit breaker cabinets should *never* be locked.
- 50. Each circuit breaker switch shall be labeled as to the lights, outlets, or appliances it controls.
- 51. Self-explanatory.
- 52. Self-explanatory.
- 53. Self-explanatory.
- 54. Self-explanatory.
- 55. Safe floor loadings must be *posted* and *observed* in all buildings and on all floors.
- 56. *Specifications for standard railing:* A standard railing shall consist of a top rail, intermediate rail, and posts. It shall have a vertical height of 42 in nominal from upper surface top rail to floor, platform, runway, or ramp level. The top rail shall be smooth surfaced throughout its length. The intermediate rail shall be approximately halfway between the top rail and the floor, platform, runway, or ramp.

Specifications for standard railing to be used on stairways: A stair railing shall be of construction similar to a standard railing (for a floor opening), but the vertical height shall not be more than 34 in nor less than 30 in from upper surface of top rail to surface of tread in line with face of visor at forward edge of tread.

- 57. All fixed stairways must rise at an angle within the limits shown:

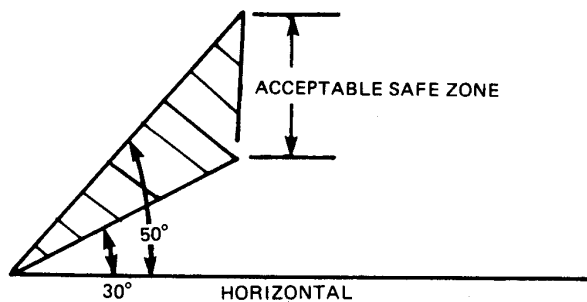

- 58. Self-explanatory.

Item Inspected	Yes	No	N.A.	Comment
59. Are flights of stairs having four or more risers equipped with railings or handrails? [.23(d)(1)]				
60. Are stair treads reasonably uniform and slip resistant? [.24(f)]				
61. Are all places kept clean and orderly and in a sanitary condition? [.141(a)(1)(i)]				
62. Are trash receptacles of approved use? [.141(a)(3)]				
63. Is every enclosed work place so constructed and maintained to prevent entrance and harborage of rodents, insects, and vermin? [.141(a)(4)]				
64. Is drinking water potable and available within 200 ft of location at which employees work? [.141(b)(1)(i)]				
65. Are toilet facilities adequate for both sexes and in accordance with regulations listed? [.141(c)(1)]				
66. Are toilet rooms constructed so that each water closet occupies a separate compartment equipped with door, latch, and clothes hanger? [.141(c)(2)(i)]				
67. Does door to toilet room have a self-closing device, and is entrance screened so interior is not visible from outside? [.141(e)(2)(iii)]				
68. Does every water closet have a hinged open-front seat made of nonabsorbent material? [.141(c)(3)(ii)]				
69. Are suitable washing facilities available and maintained in a sanitary condition? [.141(d)(1)]				
70. If employees are allowed to lunch on the premises, is an adequate space provided for that purpose? [.141(g)(2)]				
71. Are adequate waste disposal containers provided? [.141(g)(2)]				
72. Are change rooms provided for each sex where it is necessary to change clothes? [.141(e)(10)]				
73. Are change rooms provided with separate storage facilities for street clothes and protective clothing? [.141(e)]				
74. Are noise levels acceptable? [.95]				

59. Self-explanatory.
60. Stair treads should be free of cracks and other uneven areas.
61. Self-explanatory.
62. Trash receptacles used for garbage disposal should be equipped with tight-fitting lids.
63. Self-explanatory.
64. Self-explanatory.
65. Self-explanatory.
66. Self-explanatory.
67. Self-explanatory.
68. Self-explanatory.
69. Suitable washing facilities consist of a lavatory with hot and cold water, a suitable cleansing agent, and individual hand towels.
70. Self-explanatory. Employees are *not* permitted to eat in *any* laboratory that uses agents that are dangerous to health if ingested. It is the responsibility of the laboratory super-visor to enforce this rule.
71. Self-explanatory.
72. Self-explanatory.
73. Self-explanatory.
74. If any employees are exposed to noise levels greater than 90 dB at any time during the day, a safety expert should be consulted to determine if corrective measures need to be taken.

Item Inspected	Yes	No	N.A.	Comments
75. Is necessary protective equipment provided, used, and maintained in a sanitary, safe, and reliable condition? [.132(a)]				
76. Are eye protectors provided where machines or operations present the hazard of flying objects, glare, liquids, radiation? [.133(a)]				
77. Are sufficient washing facilities (including eye washes and deluge showers) available for all persons required to handle liquids that may burn, irritate, etc.? [.151(c)]				
78. Are employees in the area exposed to air contaminants only in accordance with proper limits? [.134(a)(1)]				
79. Is a respiratory protection program used where needed? [.134(a)(2)]				
80. Are written standard operating procedures governing the selection and use of respirators established? [.134(b)(1)]				
81. Has the user of the respirator been instructed and trained in the proper use and limitations of the respirator? [.134(b)(3)]				
82. Are respirators regularly cleaned, disinfected, inspected, and stored in a convenient, clean, and sanitary location? [.134(b)(5)]				
83. Has the person assigned the task requiring a respirator been determined physically able to perform the work and use the equipment by the local physician? [.134(b)(10)]				
84. Are breathing gas containers marked in accordance with the American National Standards identifying contents? [.134(d)(4)]				
85. Can gas mask canisters be identified by properly worded labels and color code or atmospheric contaminant? [.134(g)(1)]				
86. Is the compressor for supplying air to respirators equipped with necessary safety and standby equipment? [.134(d)(2)(ii)]				

75. Protective equipment, including personal protective equipment, shall be provided, used, and maintained in a sanitary and reliable condition wherever work-associated hazards may cause injury or impairment in function of any part of the body through absorption, inhalation, or physical contact. Laboratory supervisors should recognize such hazards and take the action necessary to insure that employees use adequate personal protection to avoid injury.
76. Safety glasses or goggles may be obtained through the CDC Safety Office.
77. All laboratories using liquids that may burn or irritate must be equipped with some type of emergency eye wash equipment.
78. If laboratory supervisors have any questions concerning safety concentrations of air contaminants, they should contact the CDC Office of Biosafety.
79. Respirators that are applicable and suitable for the purpose intended shall be provided when such equipment is necessary to protect the health of employees. The CDC Office of Biosafety will provide the proper respirators for a given hazard.
80. Self-explanatory.
81. Self-explanatory.
82. Self-explanatory. Respirators should be cleaned and disinfected after each use.
83. Self-explanatory.
84. Self-explanatory.
85. Self-explanatory.
86. Compressors for breathing air should be equipped with receivers of sufficient capacity to enable the respirator wearer to escape from a contaminated atmosphere in the event of compressor failure; alarms to indicate compressor failure and overheating shall be installed in the system.

Item Inspected	Yes	No	N.A.	Comment
87. Is each employee who works in an area where radioactive material is used furnished and wearing film badge? [.96(d)(2)]				
88. Is radiation exposure of individuals to the body limited to 11/4 rems per calendar quarter? [.96(b)]				
89. Is each radiation area posted with the proper radiation caution sign? [.96(e)(2)]				
90. Are all radiation area employees instructed in the safety problems, precautions, and devices to minimize exposure? [.96(i)]				
91. Are records maintained of the radiation exposure of all employees who are monitored? [.96(n)]				
92. Are radioactive materials stored and disposed properly? Are storage containers labeled? [.96(j,k)]				
<i>Compressed Gases</i>				
93. Is each portable gas container for gases such as hydrogen legibly marked with the name of contents? [.252(a)(2)(i)(a)]				
94. Are compressed gas cylinders determined in safe condition by visual and other inspection required in regulations? [.101(a)]				
95. Does the compressed gas cylinder or tank have an installed pressure relief device? [.101(c)]				
96. Are all compressed gas cylinders stored and secured so they cannot fall? [.252(a)(2)(ii)(b)]				
97. Are protection caps in place on compressed gas cylinders except when in use? [.252(a)(2)(ii)(d)]				
98. Is each mobile hydrogen supply unit secured to prevent movement? [.103(b)(1)(iv)(e)]				
99. Is the hydrogen storage area permanently marked "HYDROGEN-FLAMMABLE GAS-NO SMOKING OR OPEN FLAMES"? [.103(b)(1)(v)]				

- 87. Self-explanatory.
- 88. Self-explanatory.
- 89. Self-explanatory.
- 90. Self-explanatory.
- 91. Self-explanatory.
- 92. Self-explanatory.
- 93. Self-explanatory.
- 94. Deep dents or heavy corrosion of a gas cylinder might indicate a dangerous situation.
- 95. Self-explanatory.
- 96. When either storing or moving a compressed gas cylinder, care must be taken to prevent the cylinder from falling. OSHA requires that compressed gas cylinders either be chained or strapped in an upright position at all times.
- 97. Self-explanatory.

Preface to Questions 98 through 107

A gaseous hydrogen system is one in which the hydrogen is delivered, stored, and discharged in the gaseous form to the consumer's piping. The system includes stationary or movable containers, pressure regulators, safety relief devices, manifolds, interconnecting piping, and controls. The system terminates at the point where hydrogen at service pressure first enters the consumer's distribution piping. Systems having a total hydrogen content of less than 400 ft³ are *not* covered by the following questions.

- 98. Mobile supply units should be strapped or chained to prohibit movement.
- 99. Self-explanatory.

Item Inspected	Yes	No	N.A.	Comments
100. Is the hydrogen system in an adequately ventilated area? [.103(b)(2)(ii)(d)(1)]				
101. Is the hydrogen system 20 ft from stored flammable materials or oxidizing gases? [.103(b)(2)(ii)(d)(2)]				
102. Is it 25 ft from open flames, electrical equipment, or other sources of ignition? [.103(b)(2)(ii)(d)(3)]				
103. Is it 25 ft from concentrations of people? [.103(b)(2)(ii)(d)(4)]				
104. Is it 50 ft from intakes of ventilation or air-conditioning equipment and air compressors? [.103(b)(2)(ii)(d)(5)]				
105. Is it 50 ft from other flammable gas storage? [.103(b)(2)(ii)(d)(6)]				
106. Is it protected from damage due to falling objects or working activity in the area? [.103(b)(2)(ii)(d)(7)]				
107. Are safety relief devices arranged to discharge upward and unobstructed to the open air and prevent impingement of gas upon container, adjacent structure, or personnel? [.109(b)(1)(ii)(b)]				
<i>Storage</i>				
108. Is storage of material stable and secure against sliding, collapse, falls, or spills? [.176(b)]				
109. Are storage areas kept free from accumulation of materials that constitute hazards from tripping, fire, explosion, or pest harborage? [.176(e)]				
110. Are dangerous parts of machines or energized equipment, which may injure, colored orange where exposed? [.144(a)(2)]				
111. Is yellow the color used for designating physical hazards and caution in the particular environment? [.144(a)(3)]				
112. Is the color green used to designate "SAFETY" and location of first aid equipment? [.144(a)(4)]				
113. Is purple the color used to designate radiation hazards? [.144(a)(6)]				
114. Are the colors black and white used for traffic and housekeeping markings? [.144(a)(7)]				

- 100. Self-explanatory.
- 101. Self-explanatory.
- 102. Self-explanatory.
- 103. Self-explanatory.
- 104. Self-explanatory.
- 105. Self-explanatory.
- 106. Self-explanatory.
- 107. Self-explanatory.

- 108. Self-explanatory but very *important*,
- 109. Self-explanatory.
- 110. Self-explanatory.
- 111. Self-explanatory.
- 112. Self-explanatory.
- 113. Self-explanatory.
- 114. Self-explanatory.

Item Inspected	Yes	No	N.A.	Comments
115. Are all accident prevention signs used to minimize workplace hazards? [.145(e)(e)]				
116. Are all exposed steam and hot water pipes within 7 ft of floor or working platform covered with an insulating material or guarded? [.264(e)(4)(iii)]				
117. At all loading docks employing powered industrial trucks, are wheel chocks used to prevent trailers or railroad cars from robing? [.178(k)(1)]				
118. Is medical help readily available through personnel and first aid supplies approved by consulting physician? [.151(b)]				

115. Self-explanatory.

116. Self-explanatory.

117. Self-explanatory.

118. In the absence of an infirmary, clinic, or hospital in near proximity to the workplace that is used for treating all injured employees, a person or persons shall be adequately trained to render first aid. First aid supplies approved by the consulting physician shall be readily available.

TECHNICAL REPORT DATA

(Please read Instructions on the reverse before completing)

1. REPORT NO. EPA-600/4-79-019		2.	3. RECIPIENT'S ACCESSION NO.	
4. TITLE AND SUBTITLE Handbook for Analytical Quality Control in Water and Wastewater Laboratories			5. REPORT DATE March 1979 issuing date	
			6. PERFORMING ORGANIZATION CODE	
7. AUTHOR(S) Editor: Robert L. Booth, EMSL-Cincinnati			8. PERFORMING ORGANIZATION REPORT NO.	
9. PERFORMING ORGANIZATION NAME AND ADDRESS SAME AS BELOW			10. PROGRAM ELEMENT NO. 1BD801	
			11. CONTRACT/GRANT NO. In house	
12. SPONSORING AGENCY NAME AND ADDRESS Environmental Monitoring and Support Lab. - Cinn, OH Office of Research and Development U.S. Environmental Protection Agency Cincinnati, Ohio 45268			13. TYPE OF REPORT AND PERIOD COVERED Final	
			14. SPONSORING AGENCY CODE EPA/600/06	
15. SUPPLEMENTARY NOTES Project Officer: Robert L. Booth, EMSL-Cincinnati				
16. ABSTRACT This handbook is addressed to laboratory directors, leaders of field investigations, and other personnel who bear responsibility for water and wastewater data. Subject matter of the handbook is concerned primarily with quality control (QC) for chemical and biological tests and measurements. Chapters are also included on QC aspects of sampling, microbiology, biology, radiochemistry, and safety as they relate to water and wastewater pollution control. Sufficient information is offered to allow the reader to inaugurate or reinforce programs of analytical QC that emphasize early recognition, prevention, and correction of factors leading to breakdowns in the validity of water and wastewater pollution control data.				
17. KEY WORDS AND DOCUMENT ANALYSIS				
a. DESCRIPTORS		b. IDENTIFIERS/OPEN ENDED TERMS		c. COSATI Field/Group
Quality Assurance Quality Control Water Analysis Laboratory Performance Valid Data Analytical Quality Control		Quality Assurance Techniques Analytical Measurements Laboratory Services Instrument Selection Data Handling Skills and Training		07/3
18. DISTRIBUTION STATEMENT Release to Public		19. SECURITY CLASS (This Report) Unclassified		21. NO. OF PAGES 164
		20. SECURITY CLASS (This page) Unclassified		22. PRICE